

nanDECK Manual

by Andrea “Nand” Nini

Program version 1.28.1 – 2024-10-16

<https://www.nandeck.com>

Index

An overview	7
Editor commands	11
Getting started	13
Ranges	17
Colors	19
Labels and sequences	23
Label functions	29
AUTOLABEL	29
AUTORANGE	29
CALC	29
CASESTRING	30
COLRGB	30
CONCAT	30
CONCAT1	30
COOFRAME	31
COOFRAMES	31
COOICON	31
DIRFILES	32
ENVIRONMENT	32
EVAL	32
EXPAND	33
FILEREAD	33
FILTER	33
GRADIENTSEQ	35
GROUP	35
IMAGECREATE	36
INDEX	36
INFO	36
INFOFILE	36
JOIN	37
JOINIF	37
LABELRANGE	37
LABELSTRING	38
LABELSUB	38
LENGTH	39
LOOKUP	39
MEASURE	39
PDFMERGE	39
PDFMODULE	40
PDFPAGES	40
PRODUCT	40
RANGEADD	40
RANGECOUNT	40
RANGEINS	41
RANGEINT	41
RANGELABEL	41
RANGEMERGE	42
RANGEMUL	42
RANGEREM	42
RANGEREPE	42
RANGESUB	43
RANGETRANS	43
REPEAT	43
REPLACE	43
ROUND	43
SAVELABEL	44
SCHEMA	44
STRINGLABEL	44
STRINGSUB	44
TAGFRAME	45

TOKENIZE	45
TOKENIZESEQ	45
TRANSLATE	45
TRIMSTRING	45
Frames	47
Frame functions	51
FRAMEBAR	51
FRAMEBEZIER	51
FRAMEBOX	51
FRAMECLOCK	52
FRAMECOUNT	53
FRAMEDISK	53
FRAMEHEX	53
FRAMEIMAGE	54
FRAMELINE	54
FRAMELIST	55
FRAMEMAZE	55
FRAMEMELD	56
FRAMEMOSAIC	56
FRAMENET	57
FRAMEPATH	57
FRAMEPER	58
FRAMERECT	58
FRAMESUB	58
FRAMETRANS	58
FRAMETRI	59
Expressions	60
Comments	62
Script lists	63
Create PDF	64
Save images	65
Convert a PDF to images	66
Command-line parameters	67
Keyword wizard	68
Linked data editor	70
Virtual table	71
Visual editor	74
Configuration	76
Compare decks	82
Shortcuts	83
F.A.Q.	84
Directives	86
BACKGROUND	86
BASERANGE	86
BATCH	87
BEZIER	87
BEZIERS	88
BLEED	89
BOOKMARK	89
BORDER	90
BRUSH	91
BUTTON	92
CANVAS	92
CANVASSIZE	93
CANVASWORK	93
CARDS	93
CARDSIZE	94
CASE	94
CASEELSE	94
CHROMAKEY	94
CIRCLE	95
CMYK	96

COLOR.....	96
COLORCHANGE.....	97
COLORS.....	97
COMMENT.....	98
COMPARE.....	99
COPY.....	99
COPYCARD.....	100
CORRECTION.....	100
COUNTER.....	101
DECK.....	101
DEPTH.....	102
DICE.....	102
DISPLAY.....	103
DOWNLOAD.....	104
DPI.....	105
DRAW.....	105
DUPLEX.....	106
EDGE.....	106
ELLIPSE.....	107
ELSE.....	108
ELSEIF.....	108
END.....	108
ENDFRAME.....	108
ENDIF.....	109
ENDIMAGEENC.....	109
ENDLAYER.....	109
ENDLINK.....	109
ENDSECTION.....	110
ENDSELECT.....	110
ENDSEQUENCE.....	110
ENDVISUAL.....	110
EXPRESSION.....	110
FACTORS.....	111
FILL.....	111
FLAGS.....	112
FOLD.....	112
FOLDER.....	113
FONT.....	113
FONTALIAS.....	114
FONTCHANGE.....	115
FONTRANGE.....	115
FOOTER.....	116
FOR.....	116
FRAME.....	117
GAP.....	117
GRADIENTS.....	118
GRID.....	119
HEADER.....	120
HEXGRID.....	120
HTMLBORDER.....	121
HTMLFILE.....	122
HTMLFONT.....	123
HTMLFONTSTEP.....	124
HTMLIMAGE.....	125
HTMLKEY.....	126
HTMLLANG.....	126
HTMLMARGINS.....	127
HTMLTEXT.....	127
ICON.....	129
ICONS.....	129
IF.....	131
IMAGE.....	132

IMAGEENC	135
IMAGEFILTER.....	135
IMAGELIMIT	136
IMAGESIZE.....	136
INCLUDE.....	137
INPUTCHOICE.....	137
INPUTLIST	138
INPUTNUMBER	139
INPUTTEXT	139
LABELMERGE	140
LAYER.....	140
LAYERDRAW.....	141
LIMIT	141
LINE	142
LINERECT	143
LINK.....	144
LINKADO.....	146
LINKAUTO.....	146
LINKCACHE	146
LINKCOLOR	147
LINKCSV	147
LINKENCCSV	147
LINKENCODE.....	147
LINKEXEC	148
LINKFILL	148
LINKFILTER	148
LINKFONT	149
LINKMULCOPY	149
LINKMULDIS	149
LINKMULTI.....	150
LINKNEW.....	151
LINKRANDOM.....	151
LINKREP	151
LINKSEP.....	152
LINKSPLIT	152
LINKSTYLES	152
LINKTAB.....	152
LINKTRIM.....	152
LINKUNI.....	153
LOADPDF.....	153
LOG	154
MACRO.....	154
MANDALA.....	155
MARGINS.....	155
MERGEPDF	156
MODULEPDF.....	156
MOSAIC.....	157
NANDECK.....	158
NEXT.....	158
ORIGIN	158
OVERSAMPLE.....	159
PAGE.....	159
PAGEBREAK	160
PAGEFONT	160
PAGEIMAGE.....	161
PAGESHAPE	161
PAGETEXT.....	162
PATTERN	163
PIE	164
PNGCOMP	164
POLY.....	165
POLYGON	165

PRINT.....	166
QRCODE.....	166
RANGE.....	167
RECTANGLE.....	167
RENDER.....	168
RHOMBUS.....	168
ROUNDRECT.....	169
RTFFILE.....	169
RTFTEXT.....	170
SAVE.....	171
SAVEGIFA.....	172
SAVEPAGES.....	173
SAVEPDF.....	173
SECTION.....	174
SEED.....	174
SEEDRANGE.....	175
SELECT.....	175
SEQUENCE.....	175
SET.....	176
SPECIAL.....	177
STAR.....	177
STORE.....	178
SYMBOL.....	178
TABLE.....	179
TAG.....	180
TAGF.....	180
TAGS.....	180
TEXT.....	181
TEXTFONT.....	183
TEXTLIMIT.....	183
THREADS.....	184
TOKEN.....	184
TRACK.....	185
TRACKRECT.....	186
TRANSFORM.....	187
TRIANGLE.....	188
UNIT.....	188
VECTOR.....	189
VISUAL.....	189
VORONOI.....	190
ZOOM.....	190
Code examples.....	192
Wargame counters.....	192
Dice results.....	193
Score track.....	194
Boggle dice.....	195
Catan map.....	196
Clock.....	197
Hex board.....	198
Triangle map.....	199
Chess board.....	200
Trivia cards.....	201
Hex racetrack.....	202
Tuckbox.....	203
Number wheel.....	204
Tripples tiles.....	205
Path tiles.....	206
Combinations.....	207
Standard 52-deck of cards.....	208
Hexagonal tiles.....	209
Double-sided printing.....	210

An overview

nanDECK is a program capable of creating graphic elements from scripts: every line of a script contains a command, for rendering texts, rectangles, and other graphic elements. The program was made for creating cards, but it can be used for many other graphic objects; each card is treated like a different page, in which you can draw different graphical elements. At the start, you can write the script in the large edit box in the center of the window:

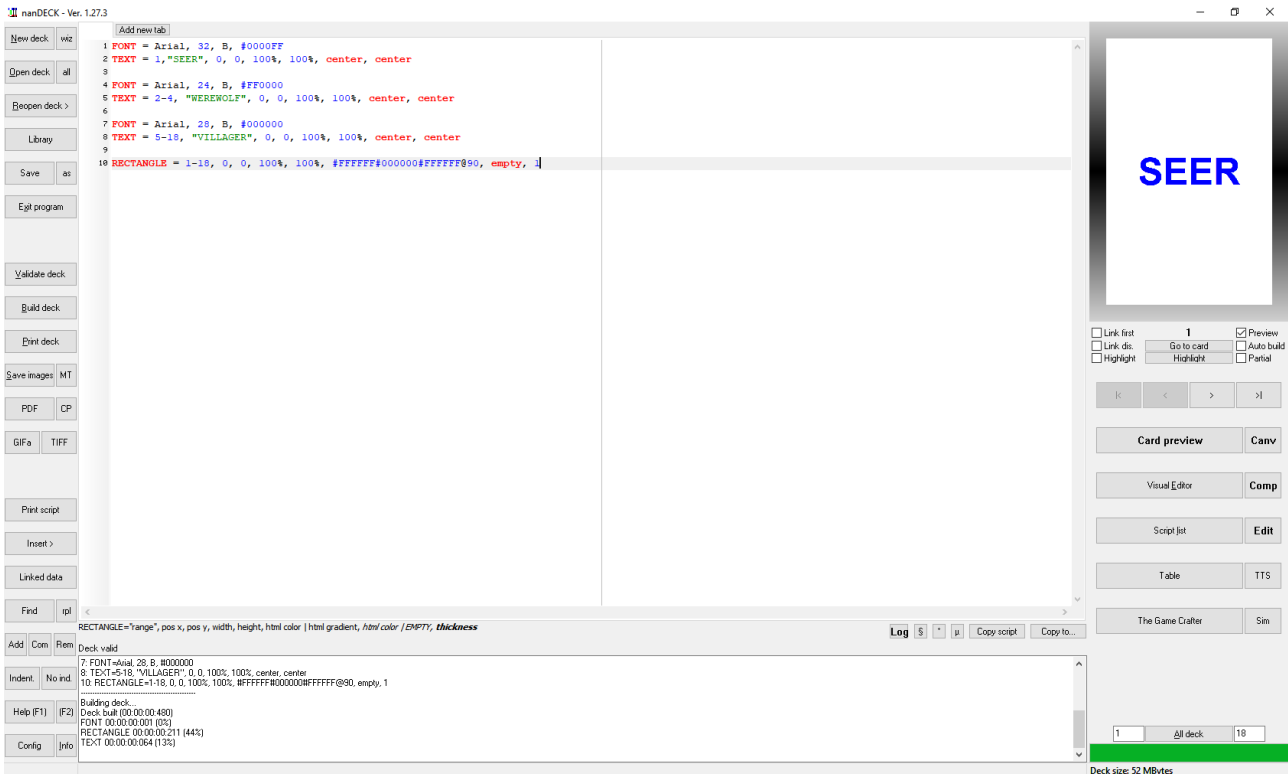

You can load a script with the “Open deck” button, save it with “Save” and “as” buttons, and create the deck with the buttons “Validate deck” and “Build deck”.

Tip: You can do both if you right-click the “Validate deck” button.

All commands start with a keyword, an equal sign (=) and a list of parameters; for many commands, the 1st parameter is a range of “cards” in which the command will be executed. The commands without a range will be evaluated only once (for example the BORDER directive to draw a border on all cards, or the CARDS directive for setting the number of the cards in the deck), or for every card (like the FONT directive); in other words, the program creates the 1st card in the deck, and executes all the script on it, then it switches on the 2nd card, and executes all the script and so on; each ranged directive is executed only if the range match.

Note: the CARDS directive is no longer needed, now the program creates automatically a deck using the information from all the directives in the script. For example, if you have a 10-30 range, the deck will be created with 30 cards.

For example, in a game of Werewolf, I need a card with a word “SEER”, three “WEREWOLF” and thirteen “VILLAGER”. The first card will be:

```
FONT = Arial, 32, B, #0000FF
TEXT = 1, "SEER", 0, 0, 100%, 100%, center, center
```

With the 1st line, I choose a font: Arial 32, bold, and blue (the #0000FF parameter); with the 2nd line I draw the word “SEER” in the center of the whole card #1 (starting from 0,0 – top left of the card, 100% width and 100% height). The other cards will be drawn with these lines:

```
FONT = Arial, 24, B, #FF0000
TEXT = 2-4, "WEREWOLF", 0, 0, 100%, 100%, center, center
```

```
FONT = Arial, 28, B, #000000
TEXT = 5-18, "VILLAGER", 0, 0, 100%, 100%, center, center
```

Note the range 2-4 and 5-18, for three and thirteen cards. Other elements can be added, for example a rectangle:

```
RECTANGLE = 1-18, 0, 0, 100%, 100%, #FFFFFF#000000#FFFFFF@90, empty, 1
```

The rectangle is on all the cards (range 1-18), from 0,0 – top left, 100% width and 100% height, with a gradient starting from white (#FFFFFF), to black (#000000), again to white, rotated 90°; not filled (empty parameter) and with a border thickness of 1”.

The flexibility of the program is that an element can be added on one or more than one card, changing only the range parameter. If you want to add an image on all the cards, you can add a line like this:

```
IMAGE = 1-18, "Logo.png", 0, 0, 20%, 20%, 0, TP
```

In the left bar in the main window, you can use these command buttons:

New deck: creates a new, empty script.

Note: if there is a file named “newScriptTemplate.txt” in the same folder with the executable, this file is automatically loaded when you press the “New deck” button.

wiz: creates a new script, by selecting some starting options.

Open deck: open a saved script.

all: open all the scripts (files with extension .txt and .nde) in a folder.

Reopen deck >: open a saved script, choosing one from a list of the last accessed scripts.

Library: shows you a list of examples (downloaded from Internet).

Save: save the current script.

as: save the current script with another name.

Exit program: close the program.

Validate deck: the program checks the syntax of the script.

Build deck: the program builds the deck of cards.

Print deck: the program prints the deck of cards.

Save images: the program saves the images of each card of the deck, see page 65.

MT: the program can launch several instances of itself, each with a range from the current deck.

PDF: the program creates a PDF file with all the cards’ images, see page 64.

CP: the program creates one image from each page of a PDF, see page 66.

GIFa: with this option, you can save the current deck into an animated GIF image (you can choose the delay between images and select an optimized palette).

TIFF: with this option, you can save a multi-page TIFF image (with RGB or CMYK color space).

Print script: prints the current script.

Insert >: this button opens a menu, where you can insert a label, a frame, a color, a gradient, an image, a font (FONT or HTMLFONT directives), a symbol, the code to use the icons from Game-icons.net font, a linked file, an include file, a folder, creates an automatic layout (b/w, color, w/b, and the same options randomized), converts all the TEXT directives into HTMLTEXT, encodes an image file into the current script, insert a “Lorem ipsum” default text, insert a definition for all missing labels or fonts.

Linked data: you can edit the data from a linked csv file, see page 70.

Find: find a string in the script editor.

rpl: find and replace a string in the script editor.

Add (CTRL+R): the program adds a comment in the current line / selected block of the script; if pressed with CTRL, the comment is added to all the lines in the script with the same directive in the current line.

Com (CTRL+E): the program toggles a comment in the current line / selected block of the script.

Rem (CTRL+U): the program removes a comment in the current line / selected block of the script; if pressed with CTRL, the comment is removed from all the lines in the script with the same directive in the current line.

Indent.: automatically apply indentations to the current script.

No ind.: remove all indentations from the current script.

Help (F1): the program shows a help page for the current directive.

(F2): the program shows a window for modifying the current directive.

Config: the configuration options, see page 76.

Info: info about the author.

In the right bar, you find a preview of the current card and if you hover the pointer on a feature, a hint box shows you the corresponding line(s) in the script; a CTRL click moves the caret to the corresponding line. In this bar you can use these command buttons:

Link first: if you check this option, only the first line from a data file (csv or spreadsheet) is read, for testing purpose.

Link dis.: if you check this option, the data file (csv or spreadsheet) is not read, and are shown only the fields' names, for testing purpose.

Highlight (checkbox): check this option to highlight with colors each line of the editor and each graphic element of the preview.

Go to card: click to select a card from the deck to be viewed.

Highlight (button): click to highlight the graphic element of the preview corresponding to the current line of the editor.

Preview: remove the check in this option if you want to hide the card preview (the rendering is faster).

Auto build: check this option if you want to see in real time the script's changes in the preview.

Partial: the program renders the current card only until the position of the cursor in the editor.

Arrow buttons: with these buttons, you move between the cards of the deck (first, prior, next, and last), with a left-click you can go to the next different card.

Card preview: this button shows you an enlarged view of the current card.

Canv: this button shows you the canvas (the card number zero).

Visual Editor: the program opens the visual editor window, see page 74.

Comp: this button shows a window for comparing different decks of cards.

Script list: in this window, you can execute several scripts, in a batch mode, see page 63.

Edit: in this window, you can edit the content of a linked spreadsheet file.

Table: the program opens the virtual table window, see page 71.

TTS: with this option you can load duplicates of card, tiles and tokens in Tabletop Simulator save file.

The Game Crafter: in this window, you can upload a deck of card directly to the website <http://www.thegamecrafter.com> for printing and/or publishing your game.

Sim: this option allows you to run a Monte Carlo simulation on the drawing of a hand of cards or a roll of dice.

All deck: this button selects all the cards in the deck to be rendered (the start-end range is in the two edit boxes to the left and right of this button).

Copy script: to copy the script (or the selected part) in the clipboard, to be pasted elsewhere.

Copy to...: to copy the script (or the selected part) in the clipboard, to be pasted with the code formatting, in BoardGameGeek, Reddit, BoardGameDesignForum, or Discord.

If you click on the file name in the status bar (the bottom line of the screen), an Explorer window opens showing the folder where the current file is located.

Editor commands

CTRL+X	Cut
CTRL+C	Copy
CTRL+V	Paste
CTRL+A	Select all
CTRL+B	Validate and build the current card
CTRL+I	Insert card's number (character §)
CTRL+O	Insert frame's number (character °)
CTRL+P	Insert frame's number (character μ)
CTRL+R	Comment current line/selected text
CTRL+U	Remove comment from current line/selected text
CTRL+E	Toggle comment on/off in current line/selected text
SHIFT+CTRL+I	Block indent
SHIFT+CTRL+U	Block un-indent
SHIFT+ALT+UP	Move block up one line
SHIFT+ALT+DOWN	Move block down one line
CTRL+D	Add new tab with a new version
SHIFT +CTRL+D	Duplicate current line/block
CTRL+M	Line break
CTRL+N	Add new tab (empty)
CTRL+T	Show windows side by side
CTRL+Y	Delete current line/block
SHIFT+CTRL+Y	Delete EOL
CTRL+Z	Undo
SHIFT+CTRL+Z	Redo
CTRL+RIGHT ARROW	Go to next word in the editor
CTRL+LEFT ARROW	Go to previous word in the editor
CTRL+TAB	Select next word in the editor
CTRL+SHIFT+TAB	Select previous word in the editor
SHIFT+F1	Select next tab in the editor
SHIFT+F2	Select previous tab in the editor
CTRL+0...9	Go to marker 0...9
SHIFT+CTRL+0...9	Set/remove marker 0...9
SHIFT+CTRL+C	Set columns selection
SHIFT+CTRL+L	Set lines selection
SHIFT+CTRL+N	Set standard selection
SHIFT+CTRL+B	Match bracket
CTRL+F	Find
CTRL+H	Replace
CTRL+G	Go to line
CTRL+SPACE	Insert label
F1	Help (current line directive)
CTRL+F1	Auto layout (white on black)
F2	Modify (current line directive)
CTRL+F2	Auto layout (color)
F3	Modify (current line directive, visual mode)
CTRL+F3	Auto layout (black on white)
SHIFT+F3	Convert selected text to upper/lower case
F4	Visual editor
CTRL+F4	Close current tab
F5	Auto build switch
CTRL+F5	Insert character for Game-Icons.net font
F6	Go to card
F7	Highlight current line
CTRL+F7	Highlight all lines switch
F8	Insert label
CTRL+F8	Insert frame
F9	Insert color
CTRL+F9	Insert gradient

F10	Partial build switch (build source until current line)
F11	Select the next font (in alphabetical order)
CTRL+F11	Select the previous font (in alphabetical order)
F12	Open the reference manual (if not present, it is downloaded)

Tip: You can copy the current card's image if you click on the card image.

Tip: You can validate and build the current card's image if you right-click on the card image. If you press CTRL, after the build the cursor in the text editor is moved to the next line (useful with "Partial" option enabled).

Tip: You can erase the current preview (and free the RAM) if you wheel-click on the card image.

Tip: You can validate and build the whole deck if you right-click on the "Validate deck" button.

Tip: You can validate, build and print the whole deck if you right-click on the "Build deck" button.

Tip: You can edit more than one script simultaneously, right click on the tab on the upper side of the screen and choose the voice "Add new tab" to add another tab to the editor.

Tip: You can move between cards using the mouse wheel.

Getting started...

This is a simple yet complete tutorial about how to create a deck of cards starting from a spreadsheet file.

First, I wrote some data, and save them as Data.xlsx:

	A	B	C	D	E	F	G	I
1	Name	Desc	Img	Icons	Value	Num		
2	Desert	A desert is a barren area of land where little precipitation occurs and consequently living conditions are hostile for plant and animal life.	desert.jpg	EF	8	1		
3	Lighthouse	A lighthouse is a tower, building, or other type of structure designed to emit light from a system of lamps and lenses and used as a navigational aid for maritime pilots at sea or on inland waterways.	lighthouse.jpg	EW	10	2		
4	Jellyfish	Jellyfish are typified as free-swimming marine animals consisting of a gelatinous umbrella-shaped bell and trailing tentacles.	jellyfish.jpg	AW	5	3		
5								
6								

Note: each column will be identified with the name in the first line (each must be different).

I start nanDECK, and as first line I link that file:

```
LINK = Data.xlsx
```

Then I save the script, as **tut01.txt**, in the same folder with the Excel file (if I want to save it in a different folder, in the LINK line I must also specify the path, for example `c:\users\nand\desktop\data\data.xls`).

I want to put the title in the top of the card, then I select a font with the line:

```
FONT = Arial, 24, , #000000
```

Font name for the 1st parameter, size for the 2nd, and color for the 4th. The 3rd is empty, this is the place for flags like **B** (bold), **I** (italic), **U** (underline) and so on (among others, if you want to shrink the font size to fit the space, use a **N** flag, if you do not want to see the text background, use a **T** flag). If you use more than one flag, put them all in this parameter (for example: **BTN**).

And add the title with this line:

```
TEXT = 1-3, [name], 0, 0, 100%, 20%
```

The 1st parameter is the range, and I want to put this text on three cards (from 1 to 3, then the syntax is 1-3), the 2nd parameter is the column name from the Excel file (enclosed in square brackets), the others are the position (0, 0 is top left), width (100% of the card's width) and height (20% is a fifth of the card's height).

Note: I can use also values in cm, and I can specify 0, 0, 6, 1.8 (for a default card of 6 x 9 cm), but with percent values I can change the size of the card without having to change every size of every element.

With a click on "Validate deck" button, "Build deck" button, the deck is created with three (ugly) cards:

Desert	Lighthouse	Jellyfish
--------	------------	-----------

Let us add some images:

IMAGE = 1-3, [img], 0, 20%, 100%, 40%, 0, P

The 0 in the 7th parameter is the angle of rotation for the image, and the P is for proportionally resize the image, if you have transparent PNGs, add a N flag in the same parameter (i.e., PN).

I have added the images' files in the same folder with the spreadsheet and the script, and this is the result after Validate + Build:



These lines are for the description:

FONT = Arial, 10, , #000000
 TEXT = 1-3, [desc], 5%, 65%, 90%, 30%, left, wordwrap

I choose a smaller font, and since the description is more than one line, I add left as horizontal alignment and wordwrap as vertical. This is the result:



These lines are for the value column:

FONT = Arial, 32, T, #FF0000
 TEXT = 1-3, [value], 0, 20%, 20%, 40%

To make the number readable on every background, I can add an outlined text:

FONT = Arial, 32, T, #FFFFFF
 TEXT = 1-3, [value], 0, 20%, 20%, 40%, center, center, 0, 100, 0.1

The "0, 100, 0.1" are respectively for angle, transparency, and outline width.

Note that these lines must be added before, because every element in a script is drawn accordingly to its position: first are drawn elements in the first lines, the last drawn are those in the bottom lines.



I have four icons (one for each element), each identified with a letter in my Excel file (and on each card, there may be more than one icon). I add these lines in the script:

ICON = 1-3, A, air.png
 ICON = 1-3, E, earth.png
 ICON = 1-3, F, fire.png
 ICON = 1-3, W, water.png
 ICONS = 1-3, [icons], 80%, 20%, 20%, 40%, 20%, 10%, 0, PN

In the last line, I specify the icons' area (80%, 20%, 20%, 40%), the size of each icon (20%, 10%), the angle of rotation (0) and to use proportional resize (P) and PNG transparency (N).

I have added the four .png files in the same folder. And this is the result:



Finally, I want to duplicate each card for the number specified in the “num” column, then I add, as first line (before the LINK), this directive:

```
LINKMULTI = num
```

I must also change every range 1-3 into 1-7. This is the result page:



This is a more compact version of the script, here the 1st parameter (the range) is empty for most directives because I want to put the text/images on all the cards, and if I leave the 1st parameter empty, nanDECK uses as a default 1-n, where n is the number of lines in the Excel file.

```
LINKMULTI = num
LINK = Data.xlsx

FONT = Arial, 24, , #000000
TEXT = , [name], 0, 0, 100%, 20%

IMAGE = , [img], 0, 20%, 100%, 40%, 0, P

FONT = Arial, 10, , #000000
TEXT = , [desc], 5%, 65%, 90%, 30%, left, wordwrap

FONT = Arial, 32, T, #FFFFFF
TEXT = , [value], 0, 20%, 20%, 40%, center, center, 0, 100, 0.1
FONT = Arial, 32, T, #FF0000
TEXT = , [value], 0, 20%, 20%, 40%

ICON = , A, air.png
ICON = , E, earth.png
ICON = , F, fire.png
ICON = , W, water.png

ICONS = , [icons], 80%, 20%, 20%, 40%, 20%, 10%, 0, PN
```

Ranges

Many directives (like IMAGE or TEXT) have a parameter for specifying for which cards will be executed that directive. A card in a range may be specified directly with a number, a list of cards with a list of numbers separated by a comma “,” and a range of cards with the first and last cards separated with a dash “-”. You can also designate a range using its first card, followed by the number symbol “#”, and a number to indicate how many cards are in it. For instance: the last of the following examples draws a rectangle on a range of cards that starts on card 10 and goes on for 5 cards, including the starting card; therefore, cards 10-14.

Examples:

```
RECTANGLE = 1, 0, 0, 6, 9, #0000FF
RECTANGLE = "1,3,5,7", 0, 0, 6, 9, #0000FF
RECTANGLE = 1-10, 0, 0, 6, 9, #0000FF
RECTANGLE = 10#5, 0, 0, 6, 9, #0000FF
```

Note: in the 2nd line the range must be enclosed in quote for the presence of commas, however, you can always enclose all ranges in quotes.

You can mix the two methods, and use a complex range, like:

```
RECTANGLE = "1-10,12,15,19-20,35#3", 0, 0, 6, 9, #0000FF
```

A number in a range can be the result of an expression (see page 60) and must be enclosed between “{” and “}”. For example:

```
RECTANGLE = 1-{2*5}, 0, 0, 6, 9, #0000FF
```

Note that a best practice is to create a range (and therefore a label) linked with the number of elements in a sequence, as when read from a linked file. For example, if you have a column named "title" in a spreadsheet, you can create a label for a range with this line:

```
[all]=1-{(title)}
```

Note that, since each column in a spreadsheet has the same length, usually is needed only one of these definitions, and you can use the label **[all]** with all the directives.

Usually, the order does not matter (1-10 is equal to 10-1) but for one command, COPYCARD, the order is important, because the source range is uses as specified, these two rows are different:

```
COPYCARD = 11-20, 1-10
COPYCARD = 11-20, 10-1
```

The 1st row gives as result this sequence of cards:

```
1,2,3,4,5,6,7,8,9,10,1,2,3,4,5,6,7,8,9,10
```

The 2nd row gives as result this sequence of cards:

```
1,2,3,4,5,6,7,8,9,10,10,9,8,7,6,5,4,3,2,1
```

There is a syntax that can be used to change that behavior, useful, for example, to invert sub-ranges of cards (for printing front-back). For example:

```
COPYCARD = 10-18, 1-9$abc>cba
```

The first group of characters is the start pattern, the second group is the destination pattern, in this case reversed in groups of three cards. You can obtain the same result manually writing:

```
COPYCARD = 10-18, "3-1,6-4,9-7"
```

Note that you are not limited at patterns of three letters, you can use all that you need (until the twenty-six letters). This syntax is useful also if you want to specify a “hollow” range, for example, if you want a rectangle only on even cards:

```
RECTANGLE = 1-10$ab>a, 1, 1, 4, 4, #FF0000
```

Note: the \$abc>cba syntax works only when the total number of cards is defined using a CARDS command.

See also: Labels and sequences chapter (page 23), AUTORANGE label function (page 29), and BASERANGE directive (page 86) about the interaction between ranges and sequences.

Colors

In this program, the colors will be defined by a string of seven characters, starting with a number sign “#” and six hexadecimal digits (using the HTML syntax), two for each component (red-green-blue), for example:

White	#FFFFFF
Black	#000000
Red	#FF0000
Green	#00FF00
Blue	#0000FF
Cyan	#00FFFF
Magenta	#FF00FF
Yellow	#FFFF00

Tip: if you use the wizard for a new deck (the “wiz” button, to the right of “New deck” button), you can check the “Include labels for HTML colors” to obtain a set of 140 label definition for many colors.

Tip: you can choose a color from a color picker, clicking on the button “Insert” and choosing the menu voice “Color”.

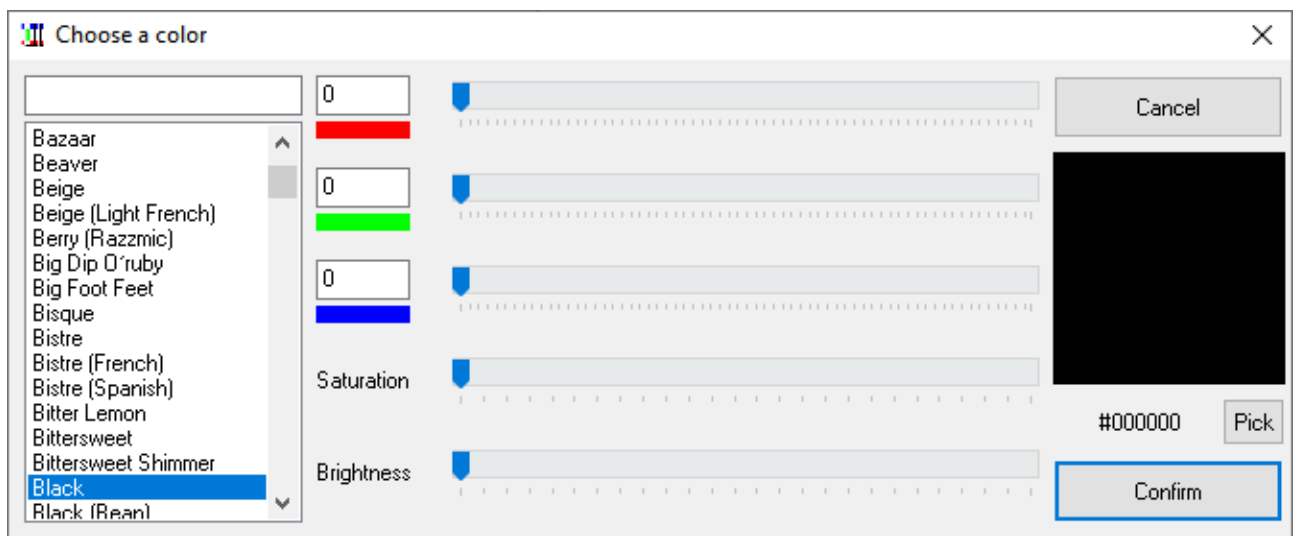

From the color picker, you can select a color from the list, adjust the three components (red, green, and blue), saturation, brightness, or pick a color from the screen (shortcut CTRL+P).

If instead of a hexadecimal digit you specify a letter “H”, you obtain a random value from 0 to 15. For example, if you want a complete random color, with this syntax you can use #HHHHHH, instead for a random hue of blue, you can use #0000HH, and so on. The letter “L” stands for the last color used, then #LLLLLL is the last color, instead #0000LL is the last blue component used.

You can concatenate more than one color to obtain a gradient, followed by a “@” to specify the angle. If you use these special values for the angle, you obtain a special gradient:

- 360 Radial gradient
- 361 Elliptical gradients
- 362 Square gradient
- 363 Rhombus gradient
- 364 Conic gradient
- 401-500 Star gradient (the number of the points is equal to the angle minus 400)

These are some examples:

From black to white, horizontal `#FFFFFF#000000@0`



From red to blue, vertical `#0000FF#FF0000@90`

From cyan to magenta, radial `#FF00FF#00FFFF@360`

From cyan to magenta, elliptical `#FF00FF#00FFFF@361`

From teal to yellow, square `#FFFF00#008080@362`

From orange to purple, rhombus `#400080#FFA500@363`

From red, to green, to blue, to red, conic `#FF0000#00FF00#0000FF#FF0000@364`

From red, to green, to blue, star (8 points) `#0000FF#00FF00#FF0000@408`

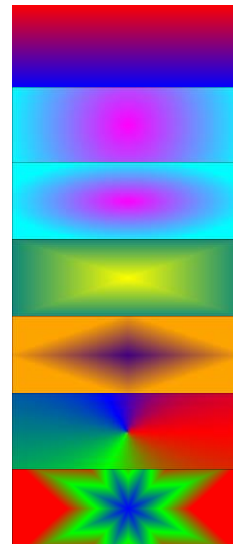

In conic and star gradients you can specify a 2nd *@angle*, to rotate the conic or the star of that angle.

With the GRADIENTS directive (see page 118) you can specify a compression factor and an origin point (with P flag) for special gradients, and for conic gradients you can also specify a rotation and a scatter angle, and for star gradients you can also specify a rotation, a “pointy” factor, a twist (positive or negative) and a scatter angle.

If you omit the “@”, the colors are randomized (and smoothed); specifying a “%” and a number, you set a threshold for the 2nd color, for example:

Blue and red, randomized `#0000FF#FF0000`

Blue and red, randomized 50% `#0000FF#FF0000%50`

Red and blue, randomized 50% `#FF0000#0000FF%50`

Blue, green, and red, randomized `#0000FF#00FF00#FF0000`

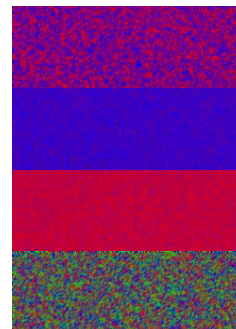

Specifying a \$ and a number, the colors are smoothed that number of times (without specifying it, the color is smoothed only one time), for example:

Blue and red `#0000FF#FF0000`

Blue and red, no smoothing `#0000FF#FF0000$0`

Red and blue, two smoothing `#FF0000#0000FF$2`

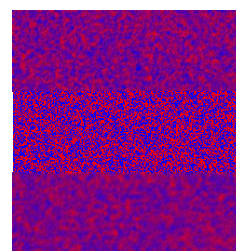

If you add a & and a number in the color, the pattern is created with a Perlin Noise algorithm, with several iteration equal to the numeric parameter, for example:

Blue and red, eight iterations `#0000FF#FF0000&8`

Blue and red, six iterations `#0000FF#FF0000&6`

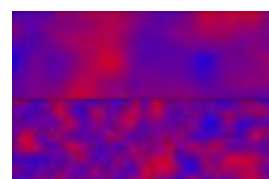

Blue and red, three iterations

#0000FF#FF0000&3



If you add a ç in the color, the random pattern is made of stripes (and you can use more ç to make the stripes longer), for example:

Blue and red, randomized

#0000FF#FF0000

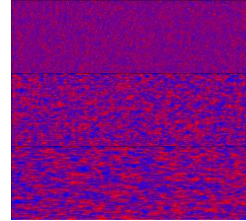

Blue and red, striped

#0000FF#FF0000ç

Blue and red, striped x 2

#0000FF#FF0000çç

Usually, the stripes are applied also at the color in edge of the object; if you do not want this effect, add a ! to the definition of the gradient.

Tip: you can choose a gradient from a visual form, clicking on the button "Insert" and choosing the menu voice "Gradient".

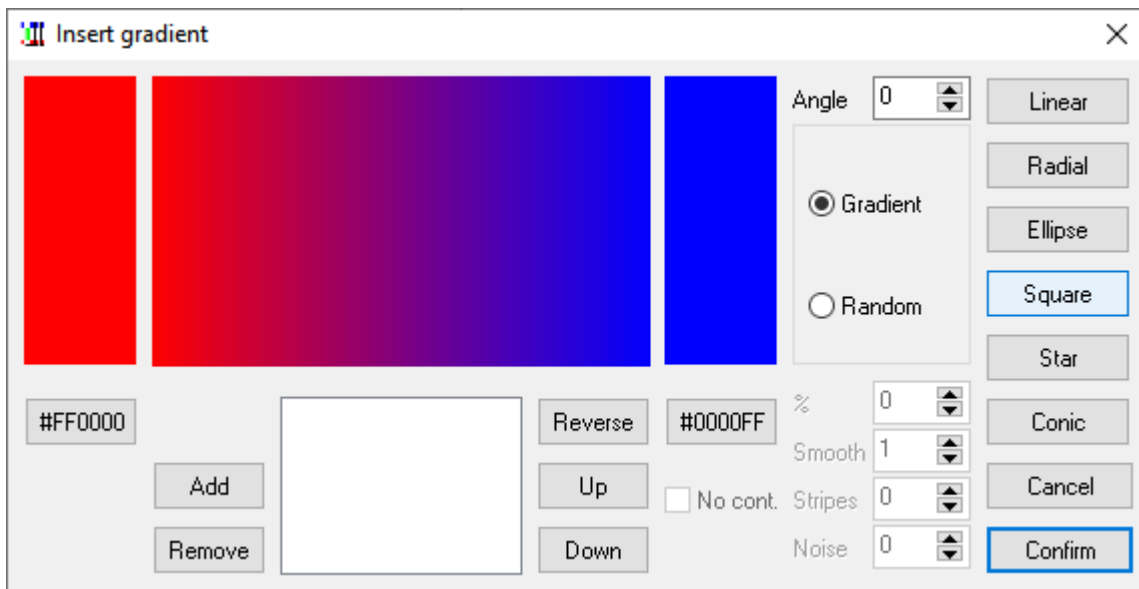

There are directives (HTMLFILE, HTMLTEXT, ICONS, IMAGE, LAYER, LAYERDRAW, PATTERN, RTFFILE, RTFTEXT, TEXT, and TEXTFONT) that have a parameter in which you can set the level of transparency, from 0 (full transparent) to 100 (full solid). You can also specify an angle for the transparency, with the format **level@angle**; in this case, the level of transparency is the starting level, ending with 0 (full transparent). If you use these special values for the angle, you obtain a special alpha gradient:

- 360 Radial gradient
- 361 Elliptical gradient
- 362 Square gradient
- 363 Rhombus gradient
- 364 Conic gradient
- 401-500 Star gradient (the number of the points is equal to the angle minus 400)

You can also add these flags to the **level@angle** parameter:

- ! The transparency is inverted, starting from zero and ending with the indicated value
- \$ The transparency starts from zero, goes to the level set in the parameter, and returns to zero
- % The transparency starts from the level set in the parameter, goes to zero, and returns to the starting level

You can also specify a compression factor for the alpha gradient with **level@angle&compression** syntax (100 is the default compression factor).

Labels and sequences

A label is used as a variable value in a script and may be initialized and used several times in the code. It can be initialized with this syntax:

```
[name] = value
```

And used specifying its name (always delimited with “[” and “]”). This is an example:

```
[alpha] = "This is a text"  
FONT = Arial, 32, , #000000  
TEXT = 1-10, [alpha], 0, 0, 6, 9, center
```

A sequence is a list of values used as a parameter in a directive. Each value is separated using the character pipe “|”. For each card in the directive’s range the program uses a different element in a sequence (restarting from the first if the sequence’s size isn’t enough to fill the range), for example, if you want ten cards, half with the word “odd” and half with the word “even”, you can use the TEXT directive, with a range 1-10 and a sequence of the two words as text parameter (“odd|even”).

```
FONT = Arial, 32, , #000000  
TEXT = 1-10, "odd|even", 0, 0, 6, 9, center
```

Sequences may be exceedingly long; you can manipulate them in a clearer manner if you use them in labels. Usually, a sequence must be on a single line, but you can split a long sequence into multiple lines, starting the first line with a “{” and ending the last line with a “}”. For example:

```
{[long] = "one|  
two|  
three|  
four|  
five|  
six|  
seven|  
eight|  
nine|  
ten"}  
FONT = Arial, 32, , #000000  
TEXT = 1-10, [long], 0, 0, 6, 9, center
```

Tip: The split-line syntax with “{” and “}” can be used not only for sequences, but with every command.

If the label contains a sequence (like in the above example), you can obtain the number of elements contained using the syntax “(name)”. It can be used directly as a parameter or in an expression. For example:

```
[alpha] = one|two|three  
FONT = Arial, 32, , #000000  
TEXT = 1-{(alpha)*2}, [alpha], 0, 0, 6, 9, center
```

The result deck will be composed of six cards, with the word sequence one-two-three-one-two-three.

When you define a label, there are some characters you can use as prefix or postfix for the [name] to obtain special behavior.

```
[name]number = value
```

The resulting value is the original value repeated *number* times. Instead, with these letters as a prefix, you can use this program as a combinatorial engine:

C	combination
P	permutation
E	derangement (permutation with no element in its original position)

F circular shift (right)
 B circular shift (left)
 CR combination with repetitions
 PR permutation with repetitions
 ER derangement with repetitions
 Tn extracts only a random sample of *n* elements instead of the full set
 Kn stops the creation of the sequence after *n* elements are added

C[name]number = object1|object2...objectN
 P[name]number = object1|object2...objectN
 E[name]number = object1|object2...objectN
 F[name]number = object1|object2...objectN
 B[name]number = object1|object2...objectN

These syntaxes create two labels with a combination and a permutation of *number* objects from the sequences, for example:

C[label1]2 = A|B|C
 P[label2]2 = A|B|C
 E[label3]2 = A|B|C
 F[label4]2 = A|B|C
 B[label5]2 = A|B|C

these labels will be translated into:

[label1] = AB|AC|BC
 [label2] = AB|AC|BA|BC|CA|CB
 [label3] = BA|BC|CA
 [label4] = AB|BC|CA
 [label5] = AB|CA|BC

With repetitions:

CR[label1]2 = A|B|C
 PR[label2]2 = A|B|C
 ER[label3]2 = A|B|C

the result will be:

[label1] = AA|AB|AC|BB|BC|CC
 [label2] = AA|AB|AC|BA|BB|BC|CA|CB|CC
 [label3] = BA|BC|CA|CC

A sample of three elements:

CRT3[label1]2 = A|B|C

one of the possible results could be:

[label1] = BC|AA|CC

Special flags:

D remove duplicate elements
 X remove “rotated” elements
 S remove elements with the same “structure”
 N randomize elements
 A sort elements in ascending order
 Z sort elements in descending order
 I keep only crossing paths
 O keep only paths that does not cross themselves

The “D” flag is useful when you have multiple elements in combinations/repetitions, for example:

```
C[label1]2 = A|B|C|C
```

will be evaluated as:

```
[label1] = AB|AC|AC|BC|BC|CC
```

If you do not want repetitions, you can add the “D” flag (as a prefix) and the result will be:

```
[label1] = AB|AC|BC|CC
```

The “X” flag needs a longer explanation. Let us say, you need to create tiles with 4 quadrants, with all the combination of three elements (plains, woods, and mountains), this is the starting script:

```
CARDSIZE = 4, 4
[QUARTER1] = 0, 0, 2, 2, 0, 4
[QUARTER2] = 0, 0, 4, 0, 2, 2
[QUARTER3] = 4, 0, 4, 4, 2, 2
[QUARTER4] = 0, 4, 2, 2, 4, 4

PR[SCHEMA]4 = P|F|M
[ALL] = 1-{(SCHEMA)}

[COLOR_P] = #00FF00
[COLOR_F] = #008000
[COLOR_M] = #C0C0C0

TRIANGLE = [ALL], [QUARTER1], [COLOR_[SCHEMA:1,1]]
TRIANGLE = [ALL], [QUARTER2], [COLOR_[SCHEMA:2,1]]
TRIANGLE = [ALL], [QUARTER3], [COLOR_[SCHEMA:3,1]]
TRIANGLE = [ALL], [QUARTER4], [COLOR_[SCHEMA:4,1]]
```

This is the result (4 pages of 81 tiles):

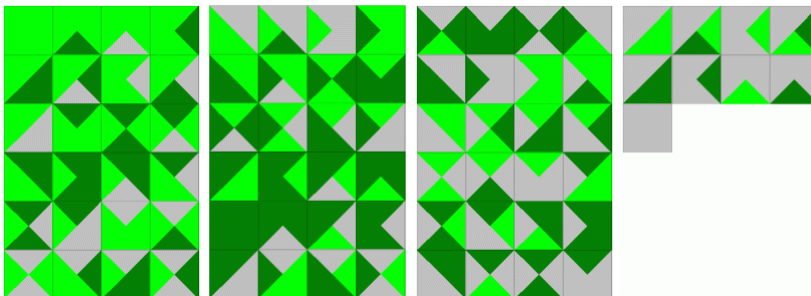

The tiles are all different, but not if you rotate them, for example, PFPF is equal to PFPF (rotated 90°). To eliminate them, you can use the “X” prefix. This is the result (1 page of 24 tiles):

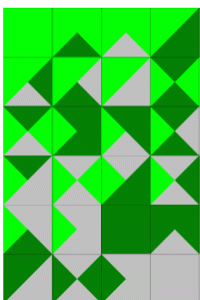

The “X” flag can be used more than once, to specify that not all the “rotations” will be considered as equals; for example, with only one “X”, the sequence 0102 is equal to:

```
1020
```

0201
2010

In a square token with a number on each side, this is equal to 90° rotations. Instead, with “XX”, the sequence 0102 is equal only to 0201 (in a square token, this is equal to considering only rotations of 180°, or rather, that rotations of 90° are not considered).

The “S” flag removes elements with the same structure: for example, the sequence 0102 has the same structure of the sequence 1210. In the previous example, from the 24 tiles, only six have a different structure:

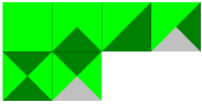

The “N” flag will be used if you want to randomize the sequence, if you write, for example:

```
N[elements] = alpha|beta|gamma|delta
```

it will be randomly evaluated each time you validate the deck, for example as:

```
[elements] = beta|gamma|delta|alpha
```

After the number of elements, you can specify one or more filters, to keep only a subset of the results, with this syntax:

```
C[name]number;char1:min1-max1;char2:min2-max2... = ...
```

In the resulting sequence are added only the results that have char1 in several occurrences between min1 and max1, char 2 between min2 and max2, and so on.

If you want to analyze only a sub-string from the result of the permutation/combination engine or an external linked file, you can use the “:” syntax to extract a sub-string, the syntax is `[label:start,number]` where *start* is the starting character and *number* is the length of the sub-string in characters. For example, in the script about tiles in the previous page, every line extract only a character from the label (composed of four characters), and associates it with another label:

```
TRIANGLE = [ALL], [QUARTER1], [COLOR_[SCHEMA:1,1]]  
TRIANGLE = [ALL], [QUARTER2], [COLOR_[SCHEMA:2,1]]  
TRIANGLE = [ALL], [QUARTER3], [COLOR_[SCHEMA:3,1]]  
TRIANGLE = [ALL], [QUARTER4], [COLOR_[SCHEMA:4,1]]
```

If the label [SCHEMA] was, as an example, “PFPM”, these lines will be evaluated as:

```
TRIANGLE = [ALL], [QUARTER1], [COLOR_P]  
TRIANGLE = [ALL], [QUARTER2], [COLOR_F]  
TRIANGLE = [ALL], [QUARTER3], [COLOR_P]  
TRIANGLE = [ALL], [QUARTER4], [COLOR_M]
```

Tip: you can view a list of labels, their contents, and choose one of them from a list, clicking on the button “Insert” and choosing the menu voice “Label”.

You can extract a single element in a sequence using the ? operator in an expression (delimited with curly brackets { and }). If you omit the number, it is used the current card (i.e., is the same to use ? or ?\$).

For example, this script will print the letter “c”:

```
[ALPHA] = a|b|c|d|e  
FONT = ARIAL, 32, , #000000  
TEXT = 1, {ALPHA?3}, 0, 0, 100%, 100%
```

There is also a syntax for creating labels with a condition and with a for...next cycle (note that you cannot define a label between standard IF...ENDIF or FOR...NEXT blocks):

```
[label] %[condition], variable, start, end, step = value
```

The [condition] parameter must be a label (only if present since it is optional); it cannot be written directly because a condition is too complex to be evaluated correctly in a single line. This is an example:

```
[check1]=[a]=1  
[check2]=[a]<>1  
[color] %[check1]=#FF0000  
[color] %[check2]=#0000FF
```

In this example, if [a] is **1**, the label [color] is red (#FF0000), if [a] is not **1**, the label [color] is blue (#0000FF).

The condition can be omitted, in this case the label is defined only if it does not already exist. In this example, the label [alpha] is red, and the label [beta] is blue:

```
[alpha]=#FF0000  
  
[alpha]%=#0000FF  
[beta]%=#0000FF
```

The label creation can be repeated in a for...next cycle, for example, if you want to define ten labels, with squares, you can write:

```
[lab(count)]%, (count), 1, 9 = {(count)^2}
```

Note that the condition parameter is empty (the comma after the % symbol), and that if the step parameter is omitted, its value is assumed equal to one. The variable (count) can be anything (the parentheses are not really needed). The result is equal to write this code:

```
[lab1]=1  
[lab2]=4  
[lab3]=9  
[lab4]=16  
[lab5]=25  
[lab6]=36  
[lab7]=49  
[lab8]=64  
[lab9]=81
```

Instead of a cycle between two values, this is an alternate syntax for the definitions of labels in a loop:

```
[label] %[condition], variable, [sequence] = value
```

In this syntax, a step in the loop is executed for each value of the sequence (value that is replaced in the variable), for example:

```
[seq] = alpha|beta|gamma  
[lab_(var)]%, (var), [seq] = test_(var)
```

The result is equal to this script:

```
[lab_alpha]=test_alpha  
[lab_beta]=test_beta  
[lab_gamma]=test_gamma
```

Note that if **[condition]** is a sequence of more than one value, the result would be a sequence; if you want to obtain a sequence without using a **[condition]** parameter, you can replace it with the **&** flag, for example:

```
[seq] = alpha|beta|gamma  
[lab]%, (var), [seq] = test_(var)
```

The result is equal to this script:

```
[lab]=test_alpha|test_beta|test_gamma
```

Note that the interaction between ranges and sequences is based on the extraction of the Nth element from a sequence when is rendered the Nth card in the range, i.e., if you have a range that does not starts with the 1st card of the deck, the elements from the sequence are apparently extracted wrongly. Example:

```
[ALPHA] = a|b|c|d|e  
FONT = ARIAL, 32, , #000000  
TEXT = 3-5, [ALPHA], 0, 0, 100%, 100%
```

In the 3rd card (the 1st of the range) shows the letter **a** (the 1st of the sequence). If you instead want to show the letter **c** you must add a BASERANGE directive:

```
BASERANGE = 1-5, ON  
[ALPHA] = a|b|c|d|e  
FONT = ARIAL, 32, , #000000  
TEXT = 3-5, [ALPHA], 0, 0, 100%, 100%
```

With the BASERANGE directive (see page 86), nanDECK uses the position of the Nth card from all the deck (and not from the range) to evaluate what element to extract from the sequence, and therefore in the 3rd card it goes the 3rd element (i.e., the letter **c**).

Label functions

AUTOLABEL

This function creates a label containing a sequence of numbers. This is the syntax:

```
[name] = AUTOLABEL(start, end, step, separator, padding)
```

For example, this line:

```
[a] = AUTOLABEL(1, 10, 2)
```

will be evaluated as:

```
[a] = 1|3|5|7|9|11
```

The standard separator is the pipe (the “|” character), if you want a different separator, you can specify it as the 4th parameter. If you specify a number in the 5th parameter, the result number is padded to the left with zeroes until the length of the number reach that parameter.

AUTORANGE

This function calculates a range starting from the previous AUTORANGE (or card 1, if it was the first instance), the only parameter is the number of cards in the range (or, if omitted, the number of lines in the linked file). This is the syntax:

```
[name] = AUTORANGE(number)
```

For example, these rows:

```
[a] = AUTORANGE(10)  
[b] = AUTORANGE(5)  
[c] = AUTORANGE(8)
```

will be evaluated as:

```
[a] = 1-10  
[b] = 11-15  
[c] = 16-23
```

You can reset the counter, using a negative number as parameter. For example, these rows:

```
[a] = AUTORANGE(10)  
[b] = AUTORANGE(-5)  
[c] = AUTORANGE(8)
```

will be evaluated as:

```
[a] = 1-10  
[b] = 1-5  
[c] = 6-13
```

CALC

This function is used to get a result from a specific function. The syntax is:

```
[label] = CALC(flag, value1, value2)
```

You can choose one of these flags:

S sine of value1

C	cosine of value1
T	tangent of value1
R	arcsine of value1
O	arccosine of value1
G	arctangent of value1
P	pi (the other parameters are not used)
M	the higher between value1 and value2
N	the lower between value1 and value2
A	the absolute of value1

CASESTRING

This function modifies the capitalization of a string, this is the syntax:

```
[label] = CASESTRING(string, flag)
```

You can choose one of these flags:

U	the string changes to uppercase
L	the string changes to lowercase
F	every first character in a string is changed to uppercase, the others to lowercase

If the flag is not specified, the string is changed to uppercase. Note that for texts printed with HTMLTEXT, there are also three flags in the HTMLFONT directive (see page 123).

COLRGB

This function creates a label containing a color, providing values from 0 to 255 for the three components, this is the syntax:

```
[name] = COLRGB(red, green, blue)
```

CONCAT

This function creates a label concatenating different strings (if you want to concatenate sequences, use JOIN, see page 37, or PRODUCT, see page 40, instead), this is the syntax:

```
[name] = CONCAT(parameter1, repeat1, parameter2, repeat2, ...parameterN, repeatN)
```

Each parameter is repeated several times equal to the next parameter. This is an example:

```
[test] = CONCAT(#000000, 3, #FFFFFF, 2)
```

Will be evaluated as:

```
[test] = #000000#000000#000000#FFFFFF#FFFFFF
```

Note: for concatenating labels and strings, it is better to use the JOIN function

CONCAT1

This function is equivalent to **CONCAT**, with a repetition of each parameter of one, this is the syntax:

```
[name] = CONCAT(parameter1, parameter2, ...parameterN)
```

Note: for concatenating labels and strings, it is better to use the JOIN function

COOFRAME

This function outputs the four coordinates of a frame (see page 47); instead of using the standard `<frame>` syntax, that is evaluated in the Validate step, this function is evaluated later, in the Build step. This is the syntax:

```
[name] = COOFRAME(frame, alignment, width, height)
```

In the alignment, width, and height optional parameters you can use the same syntax of a frame (see page 47). In the **frame** parameter you can specify another COOFRAME function, but between `<` and `>`.

COOFRAMES

This function is like COOFRAME and is used when there is more than one frame that can be selected. The 1st parameter is the number of the frame, selected from all that have the name specified in the 2nd parameter (you can also use wildcard characters like `*` and `?`):

```
[name] = COOFRAMES(number, frame, alignment, width, height)
```

In the alignment, width, and height optional parameters you can use the same syntax of a frame (see page 47). In the **frame** parameter you can specify another COOFRAME function, but between `<` and `>`.

COOICON

This function returns the space occupied by an icon (x, y, width, height), given its key; if an icon with that key is not drawn on the current card, the function returns null coordinates and the directive that uses that coordinate does not draw anything. This is the syntax:

```
[name] = COOICON(key, type, width, height, index)
```

Instead of the whole space, you can use a section of it, specifying a **type** parameter, chosen from this list:

TL	a section aligned to the top-left, using width and height as % of the icon space
TC	a section aligned to the top-center, using width and height as % of the icon space
TR	a section aligned to the top-right, using width and height as % of the icon space
CL	a section aligned to the center-left, using width and height as % of the icon space
CC	a section aligned to the center, using width and height as % of the icon space
CR	a section aligned to the center-right, using width and height as % of the icon space
BL	a section aligned to the bottom-left, using width and height as % of the icon space
BC	a section aligned to the bottom-center, using width and height as % of the icon space
BR	a section aligned to the bottom-right, using width and height as % of the icon space
TW	a section with the width of the icon space, aligned to the top, with a height as % of the icon space
CW	a section with the width of the icon space, aligned to the center, with a height as % of the icon space
BW	a section with the width of the icon space, aligned to the bottom, with a height as % of the icon space
HL	a section with the height of the icon space, aligned to the left, with a width as % of the icon space
HC	a section with the height of the icon space, aligned to the center, with a width as % of the icon space
HR	a section with the height of the icon space, aligned to the right, with a width as % of the icon space
PTL	a single point in the top-left
PTC	a single point in the top-center
PTR	a single point in the top-right
PCL	a single point in the center-left
PCC	a single point in the center
PCR	a single point in the center-right
PBL	a single point in the bottom-left
PBC	a single point in the bottom-center
PBR	a single point in the bottom-right
HTL	a triangle, the top-left half of the icon space
HTR	a triangle, the top-right half of the icon space
HBL	a triangle, the bottom-left half of the icon space
HBR	a triangle, the bottom-right half of the icon space
TTL	a triangle, pointing to the top-left of the icon space
TTC	a triangle, pointing to the top-center of the icon space
TTR	a triangle, pointing to the top-right of the icon space

TCL a triangle, pointing to the center-left of the icon space
 TCR a triangle, pointing to the center-right of the icon space
 TBL a triangle, pointing to the bottom-left of the icon space
 TBC a triangle, pointing to the bottom-center of the icon space
 TBR a triangle, pointing to the bottom-right of the icon space
 ET a line, from top-left to top-right of the icon space
 EB a line, from bottom-left to bottom-right of the icon space
 EL a line, from top-left to bottom-left of the icon space
 ER a line, from top-right to bottom-right of the icon space
 ED a line, from top-left to bottom-right of the icon space
 EG a line, from bottom-left to top-right of the icon space

If you have used the **P** flag in **ICONS**, and add an **O** flag to the *type* parameter, the resulting space is the original area of the icon (without, it returns the proportional area of the icon).

If you do not specify the *index* parameter and there is more than one icon with that specific key, the result is a group of all of the spaces occupied by these icons. Otherwise, you can specify the Nth instance of an icon by using the *index* parameter.

DIRFILES

This function creates a sequence label using names of files from a folder (and subfolders), this is the syntax:

```
[name] = DIRFILES(path, extension)
```

The extension can be a sequence of extensions, like jpg|bmp|gif.

This is an example:

```
[img] = DIRFILES("c:\images\", jpg)
```

and it will be evaluated as:

```
[img] = "c:\images\one.jpg|c:\images\two.jpg|c:\images\three.jpg"
```

Instead of an extension, you can specify in the 2nd parameter a file mask (with * and ? as wildcards). For example:

```
[img] = DIRFILES("c:\images\", "img*.jpg")
```

You can also combine the two parameters in one. For example:

```
[img] = DIRFILES("c:\images\img*.jpg")
```

ENVIRONMENT

This function reads an environment variable from the operating system, this is the syntax:

```
[name] = ENVIRONMENT(variable)
```

For example, this reads the path for the user folder:

```
[folder] = ENVIRONMENT(userprofile)
```

EVAL

This function creates a sequence with the results of the evaluation of another sequence, this is the syntax:

```
[name] = EVAL(sequence)
```

This is an example:

```
[alpha] = {1+1}|{2*3}|{3^3}
```



```
[beta] = EVAL([alpha])
```

These two lines are equivalent to:

```
[beta] = 2|6|27
```

Note: you obtain the same result with a single line:

```
[beta] = EVAL({1+1}|{2*3}|{3^3})
```

EXPAND

This function creates a sequence replicating itself *numseq* times, with each element replicated *numele* times (this parameter is optional, if not specified is treated equal to one):

```
[name] = EXPAND(sequence, numseq, numele)
```

This is an example:

```
[alpha] = a|b|c  
[beta] = EXPAND([alpha], 2, 3)
```

These two lines are equivalent to:

```
[beta] = a|a|a|b|b|b|c|c|c|a|a|a|b|b|b|c|c|c
```

The *numele* parameter can also be a sequence of numbers, if you need to specify a different number of copies of each single element. For example:

```
[alpha] = a|b|c  
[beta] = 1|2|3  
[gamma] = EXPAND([alpha], 1, [beta])
```

These three lines are equivalent to:

```
[gamma] = a|b|b|c|c|c
```

FILEREAD

This function creates a label by reading the content from a text file on disk, this is the syntax:

```
[name] = FILEREAD(filename)
```

FILTER

This function creates a sequence taking elements from another sequence, filtering and grouping them using some rules. The basic syntax is:

```
[name] = FILTER([name], filter1, filter2 ...filterN)
```

In the filterN parameters you can use wildcards: ? for any character, * for any characters, and use ranges of characters within parenthesis (as an example, **1(0-9)** matches a number from 10 to 19). For example, this script will print only elements that start with a zero (four elements on eight):

```
[ALPHA] = 000|001|010|011|100|101|110|111  
[BETA] = FILTER([ALPHA], 0*)  
FONT = ARIAL, 32, , #000000  
TEXT = 1-({BETA}), [BETA], 0, 0, 100%, 100%
```

In the 1st parameter you can specify these additional flags:

§ the sorted/added elements are used to create the new sequence

> (multiple, header) sort characters from an element in ascending order before comparing it to the filters
 < (multiple, header) sort characters from an element in descending order before comparing it to the filters
 + (multiple, header) add numbers from an element before comparing it to the filters
 @ keep only the characters specified after this flag
 # discard all the characters specified after this flag
 \$ (multiple, header) counts the maximum occurrences of a character(s) in the same element
 ? (multiple, header) counts the number of different characters(s) in the same element
 ^ (multiple, header) counts the maximum occurrences of specific character(s) in all positions on the previous accepted elements
 ~ (header) counts all the occurrences of specific character(s) in all positions on the previous accepted elements
 = (multiple, header) counts the maximum occurrences of specific character(s) in the same position on the previous accepted elements
 £ (header) counts the maximum occurrence of a straight of characters
 ° set the rule for evaluating a straight (if not specified, is used the ASCII sequence of letters/numbers)
 % (multiple) replace a character(s) with another(s), all the couples are specified after this flag
 ! counts the distance (in characters) between two copies of the same characters, specified after this flag
 & (header) the element is evaluated from his position within the sequence, starting from one
 ¬ (ALT + 0172) the condition (for including or not an element) is reversed
 _ if an element is not included, a null string is added in its position
 ç the result is not padded with zeroes to the length of the longest element
 . (multiple, header) a permutation is applied to the starting characters in each element
 : (multiple, header) a combination is applied to the starting characters in each element
 1 (ALT + 0185, multiple, header) is used to specify the number of elements in each permutation/combination
 a (ALT + 0170, header) every permutation/combination is concatenated, instead of creating new elements

You can combine multiple flags and use a space if you want to mix two similar functions, for example, a \$ followed by \$\$ can be coded as "\$ \$\$". The flags marked with *header* must be specified before the sequence, not after.

For example, this script will print only elements that contains one zero and two ones (three elements on eight):

```
[ALPHA] = 000|001|010|011|100|101|110|111
[BETA] = FILTER(>[ALPHA], 011)
FONT = ARIAL, 32, , #000000
TEXT = "1-{(BETA)}", [BETA], 0, 0, 100%, 100%
```

The flags marked with (*multiple*) in the above list (i.e.: > < + \$? ^ = % .) can be repeated, when you must consider elements not as single characters, but as strings composed with more than one character. For example, the element "0123" gives these results:

```
+      6
++     24
>     0123
>>    0123
<     3210
<<    2301
```

This is an example for utilization of "\$" flag. First, a label is created with all the permutations (with repetitions) of four elements from a set of five (a, b, c, d, and e), then, another label is created filtering only the occurrence of a three-of-a-kind and four-of-a-kind:

```
pr[a]4 = a|b|c|d|e
[b] = FILTER($[a], 3, 4)
FONT = ARIAL, 64, , #000000
TEXT = 1-{(b)}, [b], 0, 0, 100%, 100%
```

In this example, the same sequence is filtered to get only the labels that contains one or less repetitions of the same character in the same position:

```
pr[a]4 = a|b|c|d|e
[b] = FILTER(=[a], 0, 1)
FONT = ARIAL, 64, , #000000
TEXT = 1-{(b)}, [b], 0, 0, 100%, 100%
```

In this example of the replacement option (with the % option), the characters “a”, “d”, and “g” are replaced with the numbers “1”, “2”, and “3”:

```
[test_a] = abc|def|ghi  
[test_b] = FILTER($[test_a]%a1d2g3)
```

The result sequence [test_b] is equal to:

```
1bc|2ef|3hi
```

Usually, the strings found and replaced with the % option are the same length, but you can specify a null character using a ç symbol (for inserting it, type ALT + 0162). Example:

```
[test_a] = abc|def|ghi  
[test_b] = FILTER($ç[test_a]%%abxçdeçç)
```

Note the ç symbol added to disable the padding; the result sequence [test_b] is equal to:

```
xç|f|ghi
```

You can create a sequence of parameters with a “FOR=” keyword, for example, if you want ten numbers, instead of adding all of them you can use a single parameter like “1-10FOR=-” (the 2nd minus symbol is the position of the counter in the result).

Instead of a parameter used as a filter, you can specify a “mask” (with the prefix “MASK=”), that is used to apply the filter only to some characters of the elements from the sequence; you specify a character that you want to consider with a “1”, and a character to ignore with a “0”. For example, if you want to apply the rules only to the even characters of a ten-character string, use this parameter: MASK=0101010101

If there are more than one rule in the 1st parameter, and if you specify a number before the mask keyword, that mask is applied only to a single rule (1 for the 1st rule, 2 for the 2nd, and so on).

GRADIENTSEQ

This function creates a sequence of gradients, splitting one into several sections, the syntax is:

```
[name] = GRADIENTSEQ(gradient, number, element)
```

For example, with this line the program creates a sequence of three gradients:

```
[gradient] = GRADIENTSEQ(#000000#FF0000@0, 3)
```

If you do not specify the 3rd parameter, the sequence contains *number* element; instead, it contains only the Nth parameter, where N is the 3rd parameter.

GROUP

This function takes all the elements in a sequence and removes all the duplicate elements, optionally, it can return a count of all the elements adding the keyword **COUNT** in the 2nd parameter. The syntax is:

```
[name] = GROUP(sequence, function)
```

For example:

```
[alpha] = a|b|a|e|c|c|c|a|b|f|d|e  
[beta] = GROUP([alpha])  
[gamma] = GROUP([alpha], COUNT)
```

The two resulting sequences contain these values:

```
[beta] = a|b|c|d|e|f
```

```
[gamma] = 3|2|3|1|2|1
```

IMAGECREATE

This function can be used to create an image executing another nanDECK script, and it returns the name of the (temporary) image file (note that only card #1 is saved). The syntax for this function is:

```
[name] = IMAGECREATE(script, param1, param2, param3, param4, param5)
```

The optional parameters can be used in the called script as labels, named respectively [param1], [param2], [param3], [param4], and [param5]. If you want to save a PNG image with a transparent color, you can specify it as a parameter, in the format **PNGTRANS=**color (example, **PNGTRANS=#FFFFFF**). Note: in the “Config” window you can set the “Keep images made by IMAGECREATE” option to not delete the image created after each build (thus, speeding up the whole procedure).

INDEX

This function returns the position of a substring in a string, the syntax is:

```
[name] = INDEX(substring, string, number)
```

The optional parameter *number* indicates the occurrence of the searched string, if it is not indicated it is set equal to 1 (the first occurrence from the left), if it is negative, the occurrences starting from the right are searched for (-1 is the first occurrence from the right, -2 is the second and so on), if that occurrence is not present, the return value is 0 (zero). Note that both the parameters, or only one parameter, can be sequences, in this case the return is a sequence instead of a single value.

INFO

This function returns a value that depends on the flag used, the syntax is:

```
[name] = INFO(flag)
```

The flag can be one of this:

S	the filename of the current script
C	the number of the current card
N	the number of cards in the deck
R	a range from 1 to the number of cards in the deck
W	card width (in current units)
H	card height (in current units)
D	card dpi
U	name of the current units (cm/mm/inch)
Y	year (date)
M	month (date)
A	day (date)
O	hour (time)
I	minute (time)
E	second (time)
X	epoch

INFOFILE

This function returns information read from the file indicated among the parameters, the syntax is:

```
[name] = INFOFILE(flag, filename)
```

The flag can be one of this:

E	the function returns 1 for file present, 0 for file not present
W	return the width of the image file
H	return the height of the image file

JOIN

This function uses alternatively the elements from two (or more) sequences for building a new sequence, the syntax is:

```
[name] = JOIN(sequence1, sequence2, ...sequenceN)
```

The length of the new sequence is equal to the longest source sequence. This is an example:

```
[label1] = A|B  
[label2] = 1|2|3|4  
[label3] = JOIN([label1], [label2])
```

The 3rd label will be evaluated as:

```
[label3] = A1|B2|A3|B4
```

JOINIF

This function adds elements to a sequence using a condition to choose from two other sequences, the syntax is:

```
[name] = JOINIF(sequence, value1, condition, value2, sequence true, sequence false, flags)
```

Every parameter can be a single value or a sequence. The condition can be one of these symbols:

=	equal
<>	different
>	major
<	minor
>=	major or equal
<=	minor or equal
@	contains
#	it does not contain

You can choose one of these flags:

M	every set of condition, value2, sequence true, and sequence false are applied to every element of the sequence
S	the Nth set of condition, value2, sequence true, and sequence false are applied only to the Nth element of the sequence (the default)

This is an example:

```
[label] = JOINIF(A|B|C, 1|2|3, <=, 2, D|E|F, X)
```

The label will be evaluated as:

```
[label] = AD|BE|CX
```

LABELRANGE

This function creates a range, using elements from a sequence. The syntax for this function is:

```
[name] = LABELRANGE(sequence, value, offset)
```

If you specify the optional *value* parameter, the range is created with only the cards matching the *value* parameter position (wildcards * and ? are accepted). If you do not specify the *value* parameter, the default element from a sequence is considered "1". The *offset* parameter, if specified, will be added to every card of the range.

For example:

```
[sequence] = 0|1|1|0|0|1  
[label] = LABELRANGE([sequence])
```

Result:

```
[label] = "2,3,6"
```

The *item* parameter can also accept these operators (in the format *operator**value*):

=	the item's position from the sequence is included if it is equal to the value (this operator can be omitted)
<>	the item's position from the sequence is included if it is different from the value
>	the item's position from the sequence is included if it is greater than the value
<	the item's position from the sequence is included if it is smaller than the value
>=	the item's position from the sequence is included if it is greater or equal to the value
<=	the item's position from the sequence is included if it is smaller or equal to the value
@	the item's position from the sequence is included if the value is contained in it
#	the item's position from the sequence is included if the value is not contained in it

Note: if you want to select elements of a sequence other than null, use LABELRANGE([sequence],<>)

For example:

```
[sequence] = 1|2|3|4|5|6|7|8|9|10  
[label] = LABELRANGE([sequence], >=5)
```

Result:

```
[label] = "5,6,7,8,9,10"
```

LABELSTRING

This function creates a string with elements taken from a sequence. The syntax for this function is:

```
[name] = LABELSTRING(sequence, number)
```

Without the optional *number* parameter, the result is a single string, taken from concatenating every element of the sequence. If you specify a number as 2nd parameter, for every nth element a new element of the sequence is created. For example:

```
[sequence] = A|B|C|D|E|F  
[label] = LABELSTRING([sequence])
```

These two lines are equivalent to:

```
[label] = ABCDEF
```

Another example:

```
[sequence] = A|B|C|D|E|F  
[label] = LABELSTRING([sequence], 2)
```

Result:

```
[label] = AB|CD|EF
```

LABELSUB

This function extracts a sequence from another, taken only the elements in a range, the syntax is:

```
[name] = LABELSUB(sequence, "range")
```

For example:

```
[sequence] = LABELSUB(alpha|beta|gamma|delta, "1,3-4")
```

Result:

```
[sequence] = alpha|gamma|delta
```

LENGTH

This function creates a new sequence with the lengths of the elements of the sequence in the 1st (and only) parameter, the syntax is:

```
[name] = LENGTH(sequence)
```

For example:

```
[sequence] = ABC|DE|F|GH|IJK|LMNO  
[label] = LENGTH([sequence])
```

Result:

```
[label] = 3|2|1|2|3|4
```

Note that letters outside the standard codepage read from a spreadsheet are converted to HTML codes and therefore with a length longer than one, therefore if you need the correct length, you should before read the spreadsheet with a LINKUNI=OFF line (see page 153).

LOOKUP

This function creates a label/sequence with the position of a label/sequence in a sequence, the syntax is:

```
[name] = LOOKUP(value, list)
```

For example:

```
[sequence] = LOOKUP(alpha|gamma|delta, alpha|beta|gamma|delta)
```

Result:

```
[sequence] = 1|3|4
```

MEASURE

This function gives as result the distance (in the current units) from a point specified in the parameters and following a direction until a different color is found. The syntax is:

```
[name] = measure(pos x, pos y, direction)
```

The **direction** parameter can be one of the following:

```
UP  
DOWN  
LEFT  
RIGHT
```

PDFMERGE

This function creates a new PDF file, you can specify a file or a sequence of files as sources, with related page ranges (the syntax for a range is, for example, "1-10,15,18,20-30"), if the result file is not already present, it is created (otherwise, it is overwritten). This function is the equivalent of the MERGEPDF directive (see page 156). The syntax is:

```
[name] = pdfmerge("result file", "source file", "source range", rotation)
```

Example (a loop to split a pdf into single pages):

```
[pdf]%, (a), 1, PDFPAGES(source.pdf) = PDFMERGE(split(a).pdf, source.pdf, (a))
```

PDFMODULE

This function reads an existing PDF and adds an editable field. In addition to the parameters indicated, you can use the FONT directive (see page 113) to specify the name, size, and color of the text font, and the background color of the field. This function is the equivalent of the MODULEPDF directive (see page 156). The syntax is:

```
[name] = pdfmodule("result file", "source file", page, pos x, pos y, width, height, "default ", alignment, multiline, transparent)
```

Example (a loop to insert ten field):

```
FONT = Arial, 12, , #FF0000, #00FF00  
[pdf]%, (a), 1, 10 = PDFMODULE("result.pdf", "source.pdf", 1, 1, (a), 16, 1)
```

PDFPAGES

This function returns the number of the pages contained in a PDF file. The syntax is:

```
[name] = pdfpages("filename")
```

PRODUCT

This function combines two (or more) sequences, in the result every element of the first sequence is combined with every element of the second sequence (and so on), the syntax is:

```
[name] = PRODUCT(sequence1, sequence2, ...sequenceN)
```

The length of the new sequence is equal to the product of the length of all source sequences. This is an example:

```
[label1] = A|B  
[label2] = 1|2|3|4  
[label3] = PRODUCT([label1], [label2])
```

The 3rd label will be evaluated as:

```
[label3] = A1|A2|A3|A4|B1|B2|B3|B4
```

RANGEADD

This function combines several ranges in one, the syntax is:

```
[range] = RANGEADD("range1", "range2", ..."rangeN")
```

For example:

```
[range1] = "1-3"  
[range2] = "2-4"  
[range3] = "8-10"  
[range] = RANGEADD([range1],[range2],[range3])
```

Result:

```
[range] = "1-4,8-10"
```

RANGECOUNT

This function returns the number of cards in a range, the syntax is:

```
[number] = RANGECOUNT("range")
```

For example:

```
[number] = RANGECOUNT("1,4-6,10-15")
```

Result:

```
[number] = 10
```

RANGEINS

This function takes a range (1st parameter) and add every Nth position (2nd parameter) another range (3rd parameter), optionally the 4th parameter specifies how many times. The syntax is:

```
[range] = RANGEINS("range", position, "range", times)
```

For example:

```
[range] = RANGEINS("1-10", 3, "11-12")
```

Result:

```
[range] = "1,2,3,11,12,4,5,6,11,12,7,8,9,11,12,10"
```

RANGEINT

This function extracts the intersection of a series of intervals. The syntax is:

```
[range] = RANGEINT("range1", "range2",... "rangeN")
```

For example:

```
[range] = RANGEINT("1-10", "8-12")
```

Result:

```
[range] = "8,9,10"
```

RANGELABEL

This function converts a sequence of numbers into a range or a range into a sequence of numbers (the behavior is decided based on whether or not there is a sequence as a parameter).

```
[label] = RANGELABEL([sequence/range])
```

For example:

```
[seq] = 1|2|3|10  
[range] = RANGELABEL([seq])
```

Result:

```
[range] = "1,2,3,10"
```

Another example:

```
[range] = "1-3,10"  
[seq] = RANGELABEL([range])
```

Result:

```
[seq] = 1|2|3|10
```

RANGEMERGE

This function creates a new range mixing the cards from two or more ranges:

```
[range] = RANGEMERGE("range1", "range2", ..."rangeN")
```

For example:

```
[range] = RANGEMERGE(1-5,6-10)
```

Result:

```
[range] = "1,6,2,7,3,8,4,9,5,10"
```

RANGEMUL

This function creates a new range from pairs of range/number of repetitions of that range:

```
[range] = RANGEMUL("range1", num1, "range2", num2, ..."rangeN", numN)
```

For example:

```
[range] = RANGEMUL(1,2,3,4)
```

Result:

```
[range] = "1,1,3,3,3,3"
```

RANGEREM

This function removes the ranges *range2*, ... *rangeN* from *range1*, this is the syntax:

```
[range] = RANGEREM("range1", "range2", ..."rangeN")
```

For example:

```
[range1] = "1-10"  
[range2] = "3,4"  
[range3] = "7-9"  
[range] = RANGEREM([range1], [range2], [range3])
```

Result:

```
[range] = "1-2,5-6,10"
```

RANGEREPL

This function replaces empty values (-1) from *range1* with other values from *range2*, ... *rangeN*, this is the syntax:

```
[range] = RANGEREPL("range1", "range2", ..."rangeN")
```

For example:

```
[range1] = "-1,10,-1"  
[range2] = "1-10"  
[range] = RANGEREPL([range1], [range2])
```

Result:

```
[range] = "1,10,3"
```

RANGESUB

This function extracts a sub-range from another range, this is the syntax:

```
[range] = RANGESUB("range", start, number)
```

The sub-range starts from the element specified by the *start* parameter and is composed of *number* elements. If the *number* parameter is missing (or equal to zero) the sub-range goes to the end of the initial range; if the *start* parameter is equal to zero, the sub-range starts from the last element taken with another RANGESUB function (or from the start of the initial range), in a behavior like that implemented with AUTORANGE function.

For example:

```
[range1] = "1-10"  
[range] = RANGESUB([range1], 3, 4)
```

Result:

```
[range] = "3-6"
```

RANGETRANS

This function shifts the values contained in a range by a certain offset (positive or negative), this is the syntax:

```
[range] = RANGETRANS("range", offset)
```

For example:

```
[range1] = "1-10,15"  
[range2] = RANGETRANS([range1], 3)
```

Result:

```
[range2] = "4-13,18"
```

REPEAT

This function returns a string composed repeating the 1st parameter several times equal to the 2nd parameter. The syntax is:

```
[name] = REPEAT("string", number)
```

REPLACE

This function replaces in a string (or a sequence) all instances of a substring with another. The syntax for this function is:

```
[name] = REPLACE("string", "from", "to", flags)
```

You can choose one of these flags:

- C the replacement is made case-sensitive (the default)
- I the replacement is made case-insensitive
- M every pair of from/to texts are applied to every element of the 1st parameter (the default)
- S the Nth pair of from/to texts are applied only to the Nth element of the 1st parameter

ROUND

This function returns the 1st parameter rounded, the 2nd parameter specify the number of decimal digits (if not specified, it is zero, if it's a negative number, the rounding is by power of tens), the 3rd parameter is a keyword that specify if the rounding is UP, or DOWN (if you don't specify it, the rounding is down when the rounded digit is 4 or less, and up if it's 5 or more). The syntax is:

```
[name] = ROUND(value, precision, keyword)
```

SAVELABEL

This function saves the content of a label (or more than one label) into a CSV text file or a spreadsheet file (if the extension of the filename is .xls or .xlsx). The syntax for this function is:

```
[name] = SAVELABEL("filename", label1 , label2, ...labelN)
```

The result label **[name]** contains the filename. Note: do not use the [] in the label parameters.

SCHEMA

This function creates a sequence label with multiple elements taken from another sequence, to be used to create structures like tables, when the number of sub-elements may change. The syntax for this function is:

```
[name] = SCHEMA(sequence, number, header, footer, body1, body2, ...bodyN)
```

Each element in the sequence may contain multiple sub-elements, each one delimited by an underscore “_”; each element contained in the resulting sequence is composed by the **header**, one **body** for each element of the starting sequence, and one **footer**; in these resulting elements you can replace parameters with sub-elements taken from the starting sequence; the syntax for these parameters is ((N)), and the number of sub-elements that must be considered present in one of the body element of the resulting sequence is defined by the 2nd parameter (**number**) of the function. For example:

```
[data] = "one_two|three_four_five_six"  
[result] = SCHEMA([data], 2, "<table>", "</table>", "<tr> <td> ((1)) </td> <td>  
((2)) </td> </tr>")
```

The **[result]** label is equal to (spaces are added to increase readability):

```
[result] = <table><tr> <td> one </td> <td> two </td> </tr></table>|<table><tr>  
<td> three </td> <td> four </td> </tr> <tr> <td> five </td> <td> six </td>  
</tr></table>
```

You can specify multiple **body** parameters, that are use one for each sequence element, i.e., if you specify two body parameters, one is used for odd elements, and the other for even elements.

STRINGLABEL

This function creates a sequence label with elements taken from a string. The syntax for this function is:

```
[name] = STRINGLABEL("string", length)
```

The optional length parameter sets the number of characters taken for each element of the sequence. If omitted, the length is one character. For example, these two lines are equivalent:

```
[label] = STRINGLABEL("This is a test")  
[label] = "T|h|i|s| |i|s| |a| |t|e|s|t"
```

STRINGSUB

This function extracts a substring from a string, or a sequence of substrings from a sequence of string. The syntax for this function is:

```
[name] = STRINGSUB("string", start, length)
```

If the length parameter is omitted, the substring is extracted until the end of the string.

TAGFRAME

This function can be used to associate a string to a frame (to be used as a color for VORONOI directive, see page 190), or to create a label that contains the strings associated with a frame. You can also specify a list of frames using the * symbol (and the resulting label will be a sequence). The syntax for this function is (when used to create a label, do not use the **tag** parameter):

```
[name] = TAGFRAME(frame, tag)
```

TOKENIZE

This function extracts a substring from a string, using a separator that slices the string into several tokens, and a number that specify the single token extracted. The syntax for this function is:

```
[name] = TOKENIZE("string", number, separator)
```

If the separator is not specified, is assumed to be equal to “|” (pipe), note that is the same separator for the elements in a sequence. For example:

```
[result] = TOKENIZE("Alpha-Beta-Gamma", 2, -)
```

The **[result]** label would be equal to “**Beta**”

TOKENIZESEQ

This function extracts a sequence from another sequence, using a separator that slices each element of that sequence into several tokens, and a number that specify which tokens are extracted; all the tokens are concatenated in the result sequence. The syntax for this function is:

```
[name] = TOKENIZESEQ("string", number, separator)
```

For example:

```
[result] = TOKENIZESEQ("Alpha-Beta-Gamma|Delta-Epsilon-Zeta|Eta-Theta-Iota", 2, -)
```

The **[result]** label would be equal to “**Beta|Epsilon|Theta**”

TRANSLATE

This function replaces in a sequence (specified in the 1st parameter) all the elements found in another sequence (specified in the 2nd parameter) with elements taken from another sequence (specified in the 3rd parameter). The syntax is:

```
[label] = TRANSLATE(sequence, sequence key, sequence value)
```

For example, this script:

```
[test] = x|y|x|w|x|y|y|z  
[from] = x|y|z  
[to] = a|b|c  
[result] = TRANSLATE([test],[from],[to])
```

Gives this sequence as a result:

```
[result] = a|b|a||a|b|b|c
```

TRIMSTRING

This function removes the spaces at the start or at the end (or both) of a string/sequence, this is the syntax:

```
[label] = TRIMSTRING(string, flag)
```

You can choose one of these flags:

- L removes the spaces at the start of the string
- R removes the spaces at the end of the string

Frames

A frame is a special label, used when you need to identify a rectangular area used for placing a graphical content. A frame is defined used this syntax:

```
<name> = position x, position y, width, height
```

And can be used for example with a RECTANGLE directive:

```
RECTANGLE = 1, <name>, #000000
```

This is a behavior that can be done also with a label, but in a frame, you can add an alignment and a specific size, with this syntax:

```
<name, alignment, width, height>
```

The “alignment” can be a flag from this list:

TL	top-left
TC	top-center
TR	top-right
CL	center-left
CC	center-center
CR	center-right
BL	bottom-left
BC	bottom-center
BR	bottom-right

An example with all these nine alignments:

```
<frame> = 1, 1, 4, 7
FONT = Arial, 16, , #FFFFFF, #0000FF
RECTANGLE = 1, <frame>, #CCCCFF
TEXT = 1, "TL", <frame, TL, 1, 1>, CENTER, CENTER
TEXT = 1, "TC", <frame, TC, 1, 1>, CENTER, CENTER
TEXT = 1, "TR", <frame, TR, 1, 1>, CENTER, CENTER
TEXT = 1, "CL", <frame, CL, 1, 1>, CENTER, CENTER
TEXT = 1, "CC", <frame, CC, 1, 1>, CENTER, CENTER
TEXT = 1, "CR", <frame, CR, 1, 1>, CENTER, CENTER
TEXT = 1, "BL", <frame, BL, 1, 1>, CENTER, CENTER
TEXT = 1, "BC", <frame, BC, 1, 1>, CENTER, CENTER
TEXT = 1, "BR", <frame, BR, 1, 1>, CENTER, CENTER
```

Result: Figure 1

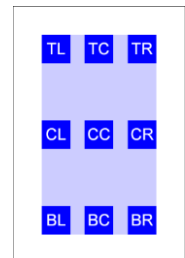

Figure 1

One between width and height can be expanded to the full extent of frame’s width or height, using this syntax and one of these alignments for width:

```
<name, alignment, height>
```

TW	top aligned, full width
CW	center aligned, full width
BW	bottom aligned, full width

Example:

```
<frame> = 1, 1, 4, 7
FONT = Arial, 16, , #FFFFFF, #0000FF
RECTANGLE = 1, <frame>, #CCCCFF
TEXT = 1, "TW", <frame, TW, 1>, CENTER, CENTER
TEXT = 1, "CW", <frame, CW, 1>, CENTER, CENTER
TEXT = 1, "BW", <frame, BW, 1>, CENTER, CENTER
```

Result: Figure 2

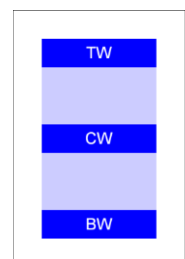

Figure 2

This syntax and these alignments are used for a full height:

```
<name, alignment, width>
```

HL full height, left aligned
HC full height, center aligned
HR full height, right aligned

```
<frame> = 1, 1, 4, 7  
FONT = Arial, 16, , #FFFFFF, #0000FF  
RECTANGLE = 1, <frame>, #CCCCFF  
TEXT = 1, "HL", <frame, HL, 1>, CENTER, CENTER  
TEXT = 1, "HC", <frame, HC, 1>, CENTER, CENTER  
TEXT = 1, "HR", <frame, HR, 1>, CENTER, CENTER
```

Result: Figure 3

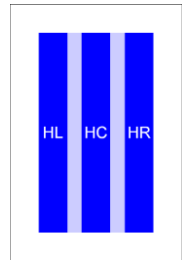

Figure 3

Another type of syntax can be used to extract only a position (useful with lines):

```
<name, alignment>
```

PTL top-left
PTC top-center
PTR top-right
PCL center-left
PCC center-center
PCR center-right
PBL bottom-left
PBC bottom-center
PBR bottom-right

```
<frame> = 1, 1, 4, 7  
RECTANGLE = 1, <frame>, #CCCCFF  
LINE = 1, <frame, PTL>, <frame, PBR>, #FF0000, 0.2  
LINE = 1, <frame, PTR>, <frame, PBL>, #FF0000, 0.2
```

Result: Figure 4

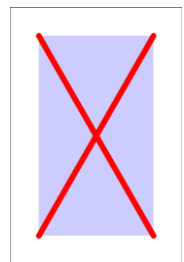

Figure 4

Instead of using two frames, you can also combine two alignments of this type in a single frame, for example, with this script the result is the same of the above example:

```
<frame> = 1, 1, 4, 7  
RECTANGLE = 1, <frame>, #CCCCFF  
LINE = 1, <frame, PTL, PBR>, #FF0000, 0.2  
LINE = 1, <frame, PTR, PBL>, #FF0000, 0.2
```

Instead of using a size (width or height) in cm, you can use a fraction of the whole frame size, using a number followed by “%%” (instead, a single “%” gives you a size equal to a fraction of the whole card). For example:

```
<frame> = 1, 1, 4, 7  
FONT = Arial, 16, , #FFFFFF, #0000FF  
RECTANGLE = 1, <frame>, #CCCCFF  
TEXT = 1, "TL", <frame, TL, 50%>, 50%>, CENTER, CENTER
```

Result: Figure 5

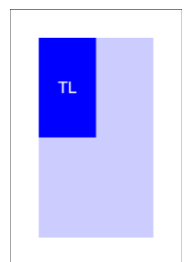

Figure 5

Tip: you can view a list of frames, their contents, and choose one of them from a list, clicking on the button “Insert” and choosing the menu voice “Frame”.

With these syntaxes, you can align a sub-frame starting from the last sub-frame, in the four directions:

TS top aligned, full width
BS bottom aligned, full width

SL left aligned, full height
 SR right aligned, full height

```
<frame> = 1, 1, 4, 7
FONT = Arial, 16, , #FFFFFF, #0000FF
TEXT = 1, TS1, <frame, TS, 1>, CENTER, CENTER
FONT = Arial, 16, , #FFFFFF, #00FF00
TEXT = 1, TS2, <frame, TS, 1>, CENTER, CENTER
FONT = Arial, 16, , #FFFFFF, #FF0000
TEXT = 1, TS3, <frame, TS, 1>, CENTER, CENTER
FONT = Arial, 16, , #FFFFFF, #FF0000
TEXT = 1, TS3, <frame, TS, 1>, CENTER, CENTER
FONT = Arial, 16, , #000000, #FFFF00
TEXT = 1, TS4, <frame, TS, 0>, CENTER, CENTER
```

Result: Figure 6

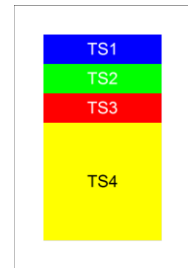

Figure 6

In this example, the first frame can also be referenced with TW, and the result did not change.
 If you specify a zero as the width/height of the element, it fills all the available space (the 4th frame in this example).

With these flags, the program extracts three coordinates from the four of a frame, useful when using the TRIANGLE directive (see page 188), for a shape that fills half of the frame:

HTL top left, top right, and bottom left
 HTR top left, top right, and bottom right
 HBL top left, bottom left, and bottom right
 HBR top right, bottom left, and bottom right

For example:

```
<frame> = 1, 1, 4, 7
RECTANGLE = 1, <frame>, #CCCCFF
TRIANGLE = 1, <frame, HTL>, #FF0000
```

Result: Figure 7

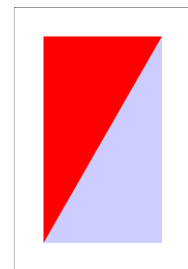

Figure 7

These flags also give three coordinates:

TTL an arrowhead with the point to the top-left corner of the frame
 TTC an arrowhead with the point to the center of the top side of the frame
 TTR an arrowhead with the point to the top-right corner of the frame
 TCL an arrowhead with the point to the center of the left side of the frame
 TCR an arrowhead with the point to the center of the right side of the frame
 TBL an arrowhead with the point to the bottom-left corner of the frame
 TBC an arrowhead with the point to the center of the bottom side of the frame
 TBR an arrowhead with the point to the bottom-right corner of the frame

For example:

```
<frame> = 1, 1, 4, 7
RECTANGLE = 1, <frame>, #CCCCFF
TRIANGLE = 1, <frame, TTC>, #FF0000
```

Result: Figure 8

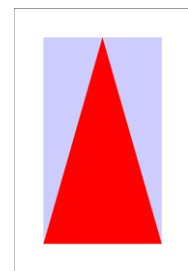

Figure 8

With several functions, you can create groups of frames, and referencing them with wildcards (the list is after this chapter):

- * a group of any characters
- ? any one character
- ~ a random frame from a group
- ! the first frame from a group, the frame is then deleted from the frame group (instead of the first frame, a random frame is selected if used with the “~” symbol)
- / normally, the frames created with a function are added to the existing ones; with this character in the frames’ name, the definition rewrites the previous frames (the name is considered without “/”)
- ° this is not a wildcard used in a frame name, but instead is used when the frame number is needed in a standard expression (with “{” and “}” delimiters)

μ this is not a wildcard used in a frame name, but instead is used when the frame name is needed in a text (without “{” and “}” delimiters).

Finally, in a frame name with ! or ~ wildcards, you can specify more than one frame adding a number before the symbol. For example, if you want three random green boxes from a grid, three blue and three red you can write:

```
[base] = FRAMEBOX(0, 0, 6, 9, 1, 1, E)
RECTANGLE = 1, <3!~base*>, #00FF00
RECTANGLE = 1, <3!~base*>, #0000FF
RECTANGLE = 1, <3!~base*>, #FF0000
GRID = 1, 0, 0, 6, 9, #000000, 0.1, 6, 9
```

Result: Figure 9

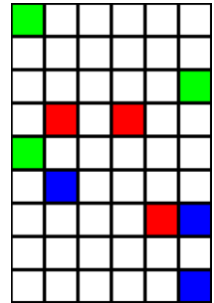

Figure 9

Note: without the “!” symbol, the randomized frames may overlay themselves. Instead, without the “~” symbol, the frames are extracted from the start of the group. For example, with this script:

```
[base] = FRAMEBOX(0, 0, 6, 9, 1, 1, E)
RECTANGLE = 1, <3!base*>, #00FF00
RECTANGLE = 1, <3!base*>, #0000FF
RECTANGLE = 1, <3!base*>, #FF0000
GRID = 1, 0, 0, 6, 9, #000000, 0.1, 6, 9
```

Result: Figure 10

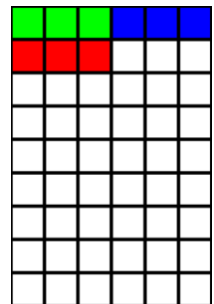

Figure 10

Frame functions

FRAMEBAR

This function creates a list of frames (see page 47) arranged in a line. The syntax for this function is:

```
[name] = FRAMEBAR(pos x1, pos y1, pos x2, pos y2, frame width, frame height, number, zoom)
```

The frames are created with a name composed from the **[name]** and a number, the number goes from “1” to the 7th parameter.

Example:

```
[bar] = FRAMEBAR(0, 0, 6, 6, 1, 1, 5)
```

You can use frames with wildcards (? for any one character, * for a group of any characters), can use the tilde (~) symbol as a flag for addressing a random frame, the exclamation mark (!) as a flag for deleting the frame after use, and referencing the current frame’s number with the degree (°) symbol (in an expression) or the current frame’s name with the micro (μ) symbol (in a text).

The *zoom* optional parameter is used if you want to resize the frame of a percent (100 is equal to no change).

FRAMEBEZIER

This function creates a list of frames (see page 47) arranged in a Bezier curve. The syntax for this function is:

```
[name] = FRAMEBEZIER(pos x1, pos y1, handle x1, handle y1, handle x2, handle y2, pos x2, pos y2, frame width, frame height, number, zoom, schema)
```

The frames are created with a name composed from the **[name]** and a number, the number goes from “1” to the 11th parameter.

Example:

```
[bezier] = FRAMEBEZIER(0, 0, 3, 0, 3, 6, 6, 6, 1, 1, 10)
```

You can use frames with wildcards (? for any one character, * for a group of any characters), can use the tilde (~) symbol as a flag for addressing a random frame, the exclamation mark (!) as a flag for deleting the frame after use, and referencing the current frame’s number with the degree (°) symbol (in an expression) or the current frame’s name with the micro (μ) symbol (in a text).

The *zoom* optional parameter is used if you want to resize the frame of a percent (100 is equal to no change). With the *schema* optional parameter you can change the precise position of the frames along the line, for example 0-20-40-60-80-100 is the default schema for six frames, 0-25-35-65-75-100 is a modified schema for six parameters; furthermore, when the schema parameter is present, a sequence is also created (with the same name as the frames and the suffix **_ang**) which contains all the values of the angles tangential to the curve (if you do not want to calculate the values for a default schema, just add **AUTO** as schema parameter).

FRAMEBOX

This function creates a list of frames (see page 47), based on a rectangular grid. The syntax for this function is:

```
[name] = FRAMEBOX(pos x, pos y, width, height, frame width, frame height, flags, zoom x, zoom y)
```

The last parameters (*zoom x* and *zoom y*) are optional, if not specified are equal to 100 (no zoom); if you want half sized frames, you can specify 50, if you want double sized frames, the value is 200, and so on. The zoom can be different between horizontal and vertical values.

The frames are created with a name composed from the **[name]** and the flag in the 7th parameter. You can use these flags:

L letters

N numbers
P zero-padded numbers
C coordinates
E coordinates with letters and numbers
R coordinates with letters and numbers (numbers are reversed)
. dot separator for C flag
- minus separator for C flag
_ underscore separator for C flag
W add only "white" squares in a chessboard
B add only "black" squares in a chessboard

With these flags, coordinates are added to each frame name:

L A, B, C, D...
N 1, 2, 3, 4...
P 01, 02, 03, 04...
C 0101,0102,0103...0201,0202,0203...
E A1,A2,A3...B1,B2,B3...
C. 1.1,1.2,1.3...2.1,2.2,2.3...
C- 1-1,1-2,1-3...2-1,2-2,2-3...
C_ 1_1,1_2,1_3...2_1,2_2,2_3...

If you did not specify any flag, the frames are created with the same name.

Example:

```
[box] = FRAMEBOX(0, 0, 4, 3, 1, 1, C_)
```

The resulting frames will be:

```
<BOX1_1> = 0, 0, 1, 1  

<BOX1_2> = 0, 1, 1, 1  

<BOX1_3> = 0, 2, 1, 1  

<BOX2_1> = 1, 0, 1, 1  

<BOX2_2> = 1, 1, 1, 1  

<BOX2_3> = 1, 2, 1, 1  

<BOX3_1> = 2, 0, 1, 1  

<BOX3_2> = 2, 1, 1, 1  

<BOX3_3> = 2, 2, 1, 1  

<BOX4_1> = 3, 0, 1, 1  

<BOX4_2> = 3, 1, 1, 1  

<BOX4_3> = 3, 2, 1, 1
```

You can use frames with wildcards (? for any one character, * for a group of any characters), can use the tilde (~) symbol as a flag for addressing a random frame, the exclamation mark (!) as a flag for deleting the frame after use, and referencing the current frame's number with the degree (°) symbol (in an expression), or the current frame's name with the micro (μ) symbol (in a text). For example, if you want to split an image into 4 images (in a 2 x 2 pattern) and save them, you can use this script:

```
[a] = FRAMEBOX(0, 0, 6, 9, 3, 4.5, N)  

IMAGE = 1, "c:\my images\earth.jpg", 0, 0, 6, 9, 0  

SAVE = 1, "c:\my images\earth_{}°.jpg", <a*>
```

FRAMECLOCK

This function creates a list of frames (see page 47) arranged in a circle (like a clock's quadrant). The syntax for this function is:

```
[name] = FRAMECLOCK(pos x, pos y, width, height, frame width, frame height,  

number, angle, zoom, start, end, factor)
```

The frames are created with a name composed from the **[name]** and a number, the number goes from “1” to the 7th parameter.

Example:

```
[clock] = FRAMECLOCK(0, 0, 4, 4, 1, 1, 8)
```

You can use frames with wildcards (? for any one character, * for a group of any characters), can use the tilde (~) symbol as a flag for addressing a random frame, the exclamation mark (!) as a flag for deleting the frame after use, and referencing the current frame’s number with the degree (°) symbol (in an expression) or the current frame’s name with the micro (μ) symbol (in a text).

The **angle** optional parameter is used if you want to rotate all the frames of a precise degree.

The **zoom** optional parameter is used if you want to resize the frame of a percent (100 is equal to no change).

The **start** and **end** optional parameters are used if you want to draw only an arc instead of full circle (both are degrees).

The **factor** optional parameter, if not zero, creates a spiral of frames, instead of a circle (positive for clockwise spirals, negative for anti-clockwise spirals).

FRAMECOUNT

This function creates a label with the number of frames from a single frame name, or a list of frame names. The syntax for this function is:

```
[name] = FRAMECOUNT(frame1, frame2, ...frameN)
```

In the **[name]** parameter you can use wildcards (? for any one character, * for a group of any characters).

FRAMEDISK

With this function, you can define a group of frames, specifying two frames, and including all the frames in the circle drawn used the first frame as a center and the latter as a radius. It works with frames created from FRAMEBOX and FRAMEHEX functions. The syntax is:

```
[diskgroup] = FRAMEDISK(frame center, frame radius)
```

For example:

```
CARDSIZE = 18, 20
HEXGRID = 1, 0, 0, 18, 20, 1, , #000000, EMPTY, 0.1
[base] = FRAMEHEX(0, 0, 18, 20, 1, E)
[diskgroup] = FRAMEDISK(basee6, basee4)
POLYGON = 1, <diskgroup>, 6, 90, #FF0000
```

FRAMEHEX

This function creates a list of frames (see page 47), based on a hexagonal grid. The syntax for this function is:

```
[name] = FRAMEHEX(pos x, pos y, width, height, hex size, flags, zoom x, zoom y,
scale x, scale y)
```

The last parameters (**zoom x**, **zoom y**, **scale x**, and **scale y**) are optional, if not specified are equal to 100 (no zoom and no scale); if you want half sized frames or half the distance between frames, you can specify 50, if you want double sized frames or double distance, the value is 200, and so on. The zoom and the scale can be different between horizontal and vertical values.

The frames are created with a name composed from the **[name]** and the flag in the 6th parameter. You can use these flags:

L	letters
N	numbers
P	zero-padded numbers
E	coordinate with letters + numbers
C	coordinates with numbers
2	coordinates interlaced with numbers

.	dot separator for C/2 flag
-	minus separator for C/2 flag
_	underscore separator for C/2 flag
O	outer frame (the default, it creates a frame suitable for drawing a circle outside the hex)
I	inner frame (it creates a frame suitable for drawing a circle inside the hex)
X	uses a pattern for obtaining “easy to cut” hexagons (“trihexagonal” tiling)
A	the hexes are arranged in horizontal lines instead of vertical
S	the line (or the column if the A flag is specified) starts with a shifted hex
M	the 5 th parameter is read as the diameter of the hex, instead of the side of the hex (the default)
T	the last row (or column) of shifted hexes is not drawn

With these flags, coordinates are added to each frame name:

L	A, B, C, D...
N	1, 2, 3, 4...
P	01, 02, 03, 04...
E	A1,A2,A3...B1,B2,B3...
C	0101,0102,0103...0201,0202,0203...
C.	1.1,1.2,1.3...2.1,2.2,2.3...
C-	1-1,1-2,1-3...2-1,2-2,2-3...
C_	1_1,1_2,1_3...2_1,2_2,2_3...
2.	1.2, 1.4, 1.6...2.3, 2.5, 2.7...
2-	1-2, 1-4, 1-6...2-3, 2-5, 2-7...
2_	1_2, 1_4, 1_6...2_3, 2_5, 2_7...

If you did not specify any flag, the frames are created with the same name.

You can use frames with wildcards (? for any one character, * for a group of any characters), can use the tilde (~) symbol as a flag for addressing a random frame, the exclamation mark (!) as a flag for deleting the frame after use and referencing the current frame with the degree (°) symbol (in an expression) or the current frame’s name with the micro (μ) symbol (in a text). For example, this script draws a circle on a random hex of the first column of a grid:

```
CARDSIZE = 18, 20
HEXGRID = 1, 0, 0, 18, 20, 1, , #000000, EMPTY, 0.1
[base] = FRAMEHEX(0, 0, 18, 20, 1, E)
ELLIPSE = 1, <~basea*>, #FF0000
```

FRAMEIMAGE

This function creates a list of frames (see page 39), taking only the frames from a source list that contain more than a percentage of a color (or a similar color) read over a reference image file. The syntax for this function is:

```
[name] = FRAMEIMAGE(frames, "image file", color, threshold, percentage)
```

If not specified, the threshold parameter is considered zero, otherwise it is the difference between the color specified as 3rd parameter and the colors read from the image; if not specified, the percentage parameter is considered 50. For example:

```
[list] = frameimage(frame*, "europe.png", #000000)
```

In this case, all the frames that start with “frame” are drawn over the “europe.png” file and are considered only those who are black over the 50% of their area.

FRAMELINE

With this function, you can define a group of frames, specifying a first frame, a last frame, and including all the frames in the shortest path between the two. It works with frames created from FRAMEBOX and FRAMEHEX functions. The syntax is:

```
[linegroup] = FRAMELINE(frame start, frame end)
```

For example:

```
CARDSIZE = 18, 20
HEXGRID = 1, 0, 0, 18, 20, 1, , #000000, EMPTY, 0.1
[base] = FRAMEHEX(0, 0, 18, 20, 1, E)
[linegroup] = FRAMELINE(basea1, baseh9)
POLYGON = 1, <linegroup>, 6, 90, #FF0000
```

FRAMELIST

With this function, you can define a group of frames, and use a single command on all of them. The syntax is:

```
[group] = FRAMELIST(frame1, frame2, ...frameN)
```

You can specify a single frame for parameter, or use another group of frames, or specify a range of frames using the syntax **frameX..frameY** (to add every frame with that name and numbered between X and Y). Before the name of the frame, you can use these flags:

```
£ the frames are reversed on each line (from top to bottom, from right to left)
$ the frames are in bidirectional order (from left to right in the first row, from right to left in the next row, and so on...)
% the frames are listed in vertical order (from left to right, from top to bottom)
%£ the frames are reversed on each vertical line (from left to right, from bottom to top)
%$ the frames are in bidirectional vertical order (from top to bottom in the first column, from bottom to top in the next column, and so on...)
- the order with the frames in a group are added is completely reversed (it can be added to each of the above combinations)
```

After the name of the frame, you can specify how many frames are skipped with the syntax **frame&N** where **N** is the number of the frames to skip.

For example, this script draws three circles on the first three hexes in the top-left corner of a grid:

```
CARDSIZE = 18, 20
HEXGRID = 1, 0, 0, 18, 20, 1, , #000000, EMPTY, 0.1
[base] = FRAMEHEX(0, 0, 18, 20, 1, E)
[group] = FRAMELIST(basea1, basea2, baseb1)
ELLIPSE = 1, <group>, #FF0000
```

FRAMEMAZE

This function reads a list of edge frames as 1st parameter (created with a FRAMEPER function), and creates another list of edge frames, arranged as a maze. The 2nd and 3rd parameters are the width and height of the rectangle defined by the edge frames. You can specify the coordinates of the starting cell (as 4th and 5th parameter), otherwise it is randomly selected (this also when set to zero); the ending cell is selected as the farthest from the starting one. You can specify a non-rectangular shape for the maze using a list of frames as 7th parameter. The syntax is:

```
[newframe] = FRAMEMAZE(frames, width, height, X start cell, Y start cell, flags, frames)
```

You can use these flags in the 6th parameter:

```
S is created a group of frames for the solution
M is created a group of frames with the sequence used in the creation of the maze
E the exit is along the edge of the maze
```

At the end of the process other two frames are created, one for the starting cell (with postfix **start**) and one for the ending cell (with postfix **end**); if the **S** flag is used is created also a group of frames for the solution (with postfix **solution**), i.e. the path from the starting to the ending cell; if the **E** flag is specified is created also two frames for the edge of the starting cell (with postfix **startedge**) and for the ending cell (with postfix **endedge**); if the **M** flag is specified is created also a group of frames with the sequence used for creating the maze (with postfix **map**).

This example creates two cards, one with the maze, starting and ending cells, and one that adds the solution:

```
[x] = 20
[y] = 20
```

```

CARDSIZE = [x], [y]
[cell] = FRAMEBOX(0, 0, [x], [y], 1, 1)
[edge] = FRAMEPER(cell, 0.1)
[maze] = FRAMEMAZE(edge, [x], [y], 0, 0, S)
RECTANGLE = 2, <mazesolution>, #FFF00
ELLIPSE = 1-2, <mazestart>, #FF0000
ELLIPSE = 1-2, <mazeend>, #00FF00
RECTANGLE = 1-2, <maze>, #0000FF
FONT = Arial, 10, T, #000000
TEXT = 2, {°}, <mazesolution>

```

FRAMEMELD

With this function, you create a new frame, merging several others. The syntax is:

```
[newframe] = FRAMEMELD(frame1, frame2, ...frameN)
```

For example:

```

CARDSIZE = 18, 20
HEXGRID = 1, 0, 0, 18, 20, 1, , #000000, EMPTY, 0.1
[base] = FRAMEHEX(0, 0, 18, 20, 1, E)
[group] = FRAMEDISK(basef3, basef1)
POLYGON = 1, <group>, 6, 90, #FF0000
[meld] = FRAMEMELD(based1, baseh5)
ELLIPSE = 1, <meld>, #0000FF, EMPTY, 0.2

```

FRAMEMOSAIC

This function reads all the images in a folder, arrange them in a rectangle, and creates a new group of frames, one for each image. If the images fill more than one instance of that rectangle, you can use a **page** parameter to specify which rectangle is drawn from all the possible choices. The frames are created with a name composed from the **[name]** and a number, the number starts from "1". The syntax for this function is:

```
[newframe] = FRAMEMOSAIC("folder", pos x, pos y, width, height, page, flags, zoom)
```

Parameters:

"folder": a folder to search, eventually with a file pattern

position x: horizontal position (in cm)

position y: vertical position (in cm)

width: width of the rectangle (in cm)

height: height of the rectangle (in cm)

page: if not specified, is equal to **1**

flags: one or more of these flags:

H	the schema is mirrored horizontally
V	the schema is mirrored vertically
S	the images are read also in the subfolders

zoom: if not specified, is equal to **100**

This function creates also a label named **namePAGES** (where **name** is the frames' prefix) with a value equal to the number of pages resulting.

FRAMENET

This function creates a new group of frames, composed with all possible couple from two groups of frames, eventually including only these contained with a range of distances. The syntax is:

```
[newframe] = FRAMENET(frame group 1, frame group 2, min distance, max distance, flags)
```

In the parameter *flags*, you can use one or more of these flags:

- L the frame(s) added is from the center of the starting frame to the center of the ending frame (it can be used for drawing lines), this is the default option
- N the frame(s) added is the ending frame
- 1 the frame(s) added are only from the 1st quadrant (top-right)
- 2 the frame(s) added are only from the 2nd quadrant (bottom-right)
- 3 the frame(s) added are only from the 3rd quadrant (bottom-left)
- 4 the frame(s) added are only from the 4th quadrant (top-left)

If you did not specify any of flags *1234*, the frames are taken from all the starting lists.

For example, this is a net from all the points in a rectangular grid, with a maximum distance of four units:

```
[net0] = FRAMEBOX(0, 0, 6, 9, 1, 1, L)
[net1] = FRAMENET(net0*, net0*, 0, 4)
LINERECT = 1, <net1>, #000000
```

Another example, this is a “star map”, connecting ten random “planets” in a hexagonal grid with a distance from two to four units:

```
[map0] = FRAMEHEX(0, 0, 6, 9, 0.1, L, 50%)
[map1] = FRAMELIST(10!~map0*)
[map2] = FRAMENET(map1, map1, 2, 4)
LINERECT = 1, <map2>, #000000
ELLIPSE = 1, <map1>, #0000FF
```

FRAMEPATH

With this function, you can define a group of frames, specifying a first frame, a last frame, and including all the frames in the shortest path between the two, and optionally remove a list of frames (specified in the 4th parameter) from the result. It works with frames created from FRAMEBOX. The syntax is:

```
[pathgroup] = FRAMEPATH(frame start, frame end, flags, exclusions)
```

In the parameter *flags*, you can use one or more of these flags:

- F add **frame1** to the result group
- L add **frame2** to the result group
- D delete the frames used for the path
- S delete the frame used as 1st parameter (start frame)
- E delete the frame used as 2nd parameter (end frame)
- T use the shortest path

For example:

```
[grid] = FRAMEBOX(0, 0, 6, 9, 0.5, 0.5, C)
[path1] = FRAMEPATH(grid0203, grid1116, D)
[path2] = FRAMEPATH(grid0203, grid1116, D)
[path3] = FRAMEPATH(grid0203, grid1116, D)
RECTANGLE = 1, <grid>, #0000FF, #FF0000, 0.1
ELLIPSE = 1, <path1>, #AAAAAA, #00FF00, 0.05
ELLIPSE = 1, <path2>, #AAAAAA, #0000FF, 0.05
ELLIPSE = 1, <path3>, #AAAAAA, #FF0000, 0.05
```

FRAMEPER

This function creates a new group of frames, adding for each starting frame the four frames from its sides (the starting frame is considered rectangular). The syntax is:

```
[newframe] = FRAMEPER(frame group, width, flags, margin)
```

The **width** parameter specifies the width of the left and right frames, and the height of top and bottom frames. In the parameter **flags**, you can use one or more of these flags:

- 1 a frame for the top side of the rectangular frame is added to the result
- 2 a frame for the right side of the rectangular frame is added to the result
- 3 a frame for the bottom side of the rectangular frame is added to the result
- 4 a frame for the left side of the rectangular frame is added to the result
- V with this flag the frames are created in vertical order (instead of a horizontal order)
- N with this flag the frames are created with individual names: *nameN* (top), *nameE* (right), *nameS* (bottom), *nameW* (left)
- E with this flag only single copy frames are added, i.e. internal frames are not included in the group, only external ones

If you did not specify any of flags **1234**, all the four frames are added. The margin parameter specifies how much space is added to the left and to the right (for horizontal sides) and to the top and to the bottom (for vertical sides) of the frame.

FRAMERECT

With this function, you can define a group of frames, specifying two frames, and including all the frames in the rectangle drawn used the first frame as top-left and the latter as bottom-right. It works with frames created from FRAMEBOX and FRAMEHEX functions. The syntax is:

```
[rectgroup] = FRAMERECT(frame start, frame end)
```

For example:

```
CARDSIZE = 18, 20
HEXGRID = 1, 0, 0, 18, 20, 1, , #000000, EMPTY, 0.1
[base] = FRAMEHEX(0, 0, 18, 20, 1, E)
[rectgroup] = FRAMERECT(baseb3, basei6)
POLYGON = 1, <rectgroup>, 6, 90, #FF0000
```

FRAMESUB

With this function, you can define a new frame from another frame (1st parameter), removing items from a third frame (2nd parameter). The syntax is:

```
[group] = FRAMESUB(frame1, frame2)
```

For example, this script uses two square group of frames for creating a third hollow group of frames (subtracting the second from the first):

```
[grp_a] = FRAMEBOX(0, 0, 6, 6, 1, 1, C)
[grp_b] = FRAMEBOX(1, 1, 4, 4, 1, 1, C)
[grp_c] = FRAMESUB(grp_a*, grp_b*)
ELLIPSE = 1, <grp_c*>, #00FF00
```

FRAMETRANS

This function creates a new group of frames, taking all the frames from a group, and applying to them a horizontal and a vertical offset, and optionally a change in width and height. The syntax is:

```
[newframe] = FRAMETRANS(frame group, x offset, y offset, width change, height change)
```

For example, this line takes all frames from group **test**, and creates a group **test_trans** shifted right of 0.5:

```
[test_trans] = FRAMETRANS(test, 0.5, 0)
```

FRAMETRI

With this function, you can define a group of frames, specifying three frames, and including all the frames in the triangle drawn used the frames as vertexes. It works with frames created from FRAMEBOX and FRAMEHEX functions. The syntax is:

```
[trianglegroup] = FRAMETRI(frame1, frame2, frame3, flags)
```

You can use these flags in the 4th parameter:

O = does not include the outer frames

I = does not include the inner frames

For example:

```
CARDSIZE = 18, 20  
HEXGRID = 1, 0, 0, 18, 20, 1, , #000000, EMPTY, 0.1  
[base] = FRAMEHEX(0, 0, 18, 20, 1, E)  
[trianglegroup] = FRAMETRI(baseb3, basei6, basec10)  
POLYGON = 1, <trianglegroup>, 6, 90, #FF0000
```

Expressions

Expressions may be used to calculate numeric parameters or numbers in TEXT parameters, these delimited with “{” and “}”. You can use numbers (integer and decimal separated with a dot “.”), parenthesis and these operators:

+	addition
-	subtraction
*	multiplication
/	division
^	exponentiation
#	modulus
£	integer division

For changing the order of operations, you can use “(, “)”, “{” and “}”, these are treated like the same. You cannot use “[” and “]” (used for labels).

For example, these are valid expressions:

```
RECTANGLE = 1, 0, 0, (1+2)*2, (1+2)^2, #FF0000
TEXT = 1, "Result {(2+2)^2}", 0, 0, 6, 9, center
```

This is a special variable: the paragraph character (§) gives you the current card number; for example, that script creates ten cards, each with a number from 1 to 10:

```
FONT = Arial, 32, , #000000
TEXT = 1-10, "{§}", 0, 0, 6, 9, center
```

That script creates ten cards, each with a random number from 1 to 100:

```
FONT = Arial, 32, , #000000
TEXT = 1-10, "{1d100}", 0, 0, 6, 9, center
```

Counters are variables, that can be used in expressions; there are two kinds of counter, these are used for integer values:

```
A B C D E F G H I J
```

And these are used for floating-point values:

```
AA BB CC DD EE FF GG HH II JJ
```

A counter can be initialized with COUNTER directive:

```
COUNTER = 1, A, 1
```

and later re-used in an expression:

```
RECTANGLE = 1, 0, 0, A, A, #00FF00
```

A counter can be auto incremented with a pre- and/or a post- number. If A has a value of 10, this command:

```
TEXT = 1, "{1A2}", 0, 0, 3, 3, center
```

will give an output of 11, and A will have a value of 13 after that line.

The counter D is a special case, it has been changed for default into a dice (see DICE keyword, page 102), to give a random value, the syntax is *ndf*, where *n* is the number of dice, each with *f* faces. If not specified, *n* is set to one, and *f* is set to six.

These are special symbols:

Z Format
X Repeat

The “Z” symbol may be used when you need to format a decimal value with a fixed number of digits. The syntax is *valueZmask*, where the mask is a sequence characters for the integer part, a dot (“.”) and a sequence characters for the decimal part. The characters that can be used for the mask are:

0 a digit taken from the number, if there is not a digit in that position, a zero (“0”) is written instead
a digit taken from the number, if there is not a digit in that position, a space (“ ”) is written instead

For example:

```
FONT = Arial, 32, , #000000  
TEXT = 1, "{4/3Z00.00}", 0, 0, 6, 9, center, center
```

The result will be a “01.33” printed on the card.

The syntax for the “X” symbol is *textXnumber* and duplicates the *text* for several times. For example:

```
FONT = Arial, 32, , #000000  
TEXT = 1-5, "{*X$}", 0, 0, 6, 9, center, center
```

Will output an asterisk on the 1st card, two asterisks on the 2nd card, three on the 3rd and so on.

Comments

Comments can be inserted in scripts, marking them with a character on the start of the line. The character can be an apostrophe (') or a semicolon (;) or a custom character selected from the “Config” window.

Example:

```
CARDS = 52  
'This is a standard deck
```

From the “Config” window you can also check the “Use in-line comments marked by ...” option, and after that you can use a syntax like that:

```
CARDS = 52 `` This is a standard deck
```

If you use a custom character and open your script on another computer (with a different configuration) your comments will not be evaluated as such. To avoid this problem, you must include a COMMENT directive at the start of your script (see page 98).

You can apply or remove the current comment's character in a block of selected text with two buttons on the right side of the main window: “+Com” for apply comments and “-Com” for removing comments.

Script lists

If you must work on multiple scripts, you can create a list for manipulating them. You can activate this option clicking on the button “Script list”:

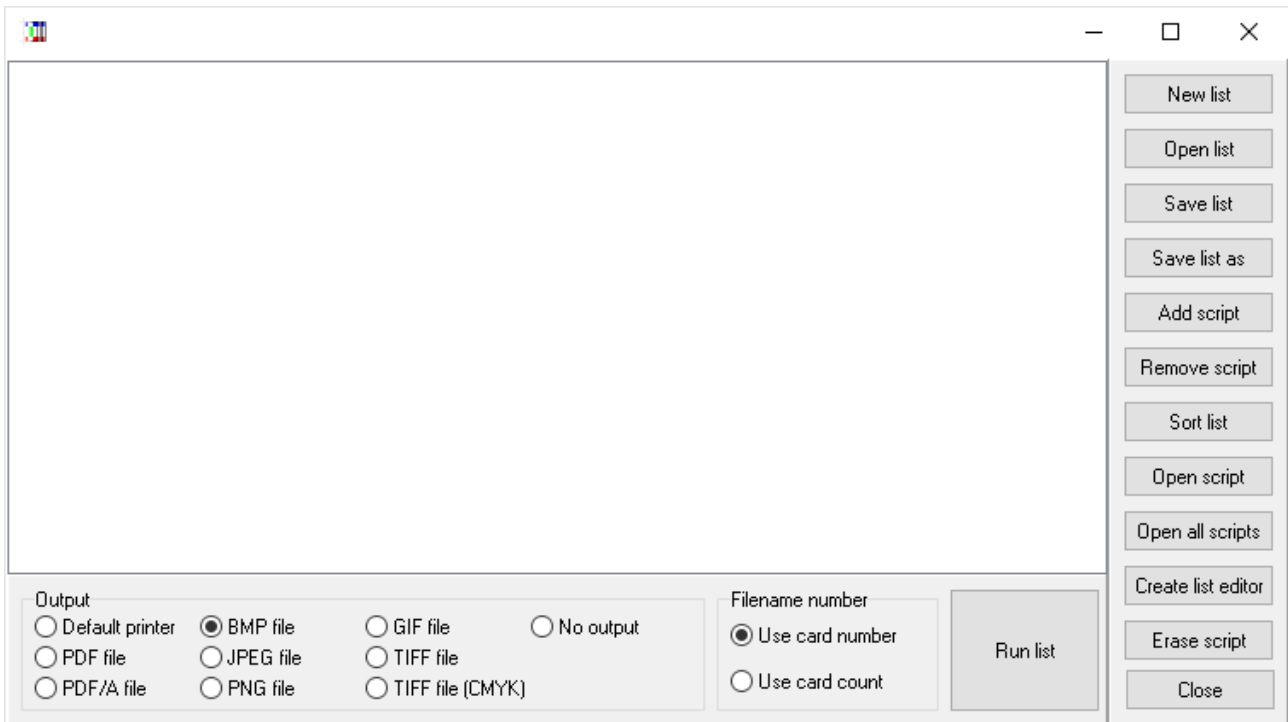

With the buttons on the right side, you can create a new list, open an old list, save the current list (with the current name or specifying another), add another script to the list, remove a script and sort the list. You can also open the selected script, or open all of them (in multiple tabs), create a list from all the current scripts and erase the selected script.

With the button “Run list” you can launch a “Validate and build” task on all the scripts listed in this window, choosing the output for them with the “Output” box: you can print the result, create PDF, and save the images in bmp, jpg, png or tiff format (the latter with standard and CMYK color space). With the “Filename number” box you can choose if the filename must be chosen from card number or card count: it can be different if you use a PRINT directive (see page 166) in your scripts.

Create PDF

The button “**PDF**” in the main window opens this form:

Save deck as a PDF file

PDF filename: test.pdf

PDF author:

PDF/A

Use JPEG Compression for images

Use scaled images

PDF compression level

None

Low

Default

Max

Save a copy with a CMYK colorspace

Gswin32c.exe:

ICC profile:

With this form, you can specify a filename and an author for the PDF file.

PDF/A: with this option, the PDF file is saved in this format.

Use JPEG Compression form images: with this option enabled all the images in the PDF file are internally stored in JPEG format.

Use scaled images: with this option enabled, the program uses a high image compression for the PDF file, reducing its size (and its quality).

PDF compression level: you can choose between four standard compression level for the images (None, Low, Default and Max).

Save a copy with a CMYK color space: if you have installed Ghostscript (<http://www.ghostscript.com>) you can also save it with CMYK color space (instead of RGB), specifying the path for the executable (Gswin32c.exe), and use an ICC color profile.

Save images

The button “MT” in the main window opens this form:

The dialog box is titled "Save images - multi threaded". It features a "Path:" text input field with a "Browse..." button to its right. Below the path field is an "Image format" section containing eight radio button options: BMP (selected), PNG, TIF, PDF, JPG, GIF, TIF (CMYK), and PDF/A. There are two sliders: "Threads: 2" and "Oversamp.: 1". At the bottom right, there are "Cancel" and "Save" buttons.

With this form, you can specify a path for saving the cards' images, the file format, the number of threads to be used, the DPI (see page 105) and oversampling (see page 159) values.

Note: every thread uses a separate memory pool, thus it is possible to use more than 4GBytes of memory.

Convert a PDF to images

The button “CP” in the main window opens this form:

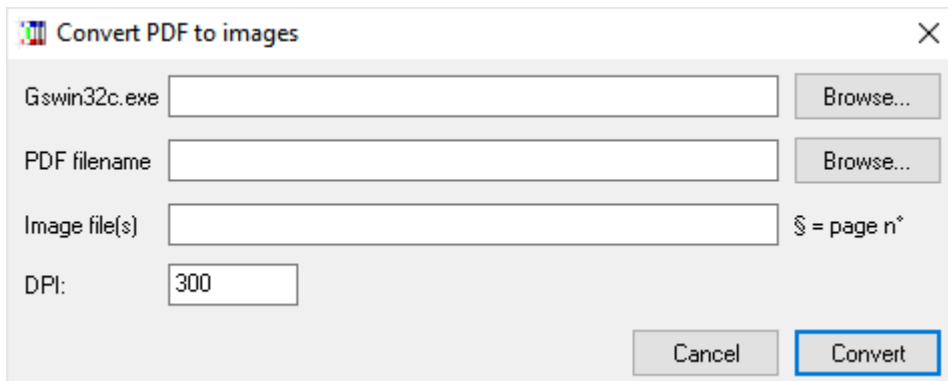

The screenshot shows a dialog box titled "Convert PDF to images" with a close button (X) in the top right corner. It contains four input fields and two buttons. The first field is labeled "Gswin32c.exe" and has a "Browse..." button to its right. The second field is labeled "PDF filename" and also has a "Browse..." button to its right. The third field is labeled "Image file(s)" and has a "\$ = page n*" label to its right. The fourth field is labeled "DPI:" and contains the value "300". At the bottom right of the dialog are two buttons: "Cancel" and "Convert".

If you have installed Ghostscript (<http://www.ghostscript.com>) you can convert PDF files into images. The first field is for the Ghostscript executable; the second is the name of the PDF file, the third is for the resulting images (you can use the \$ character for the page number); the fourth field is for the DPI resolution of the final images.

Command-line parameters

You can run nanDECK from the command line (if you want to execute a script in a batch, for example). The syntax is:

```
nanDECK <script file> <1st action> <2nd action> ... <nth action>
```

The *action* parameter can be one or more of the following:

/createbmp	
/createjpg	
/createpng	the program creates all the cards and saves them in bmp/jpg/png/gif/tif formats (also with CMYK color space), one file for each card
/creategif	
/createtif	
/createtifcmyk	
/creategifa	
/createpdf	the program creates all the cards and saves them in one single file in animated-gif or pdf format
/createpdfa	
/print	the program creates all the cards and prints them with the default printer
/exec	the program runs the script (useful when using SAVE directive)
/range=	the program creates only a range of the card, with the syntax start-end (for example /range=1-10)
/output=	this is the path for the resulting files
/dpi=	you can specify a different DPI value (the value in the script is not used)
/oversample=	you can specify an oversample value (the value in the script is not used)
/name=	the program uses a label for the name of the card when saved as individual images
/[label]=value	the program adds a label with that name and that value
/nopdfdiag	the dialog for the creation of a pdf file is not shown

For example, to save all images obtained with script “c:\my scripts\test01.txt” in png files, you can write:

```
nanDECK "c:\my scripts\test01.txt" /createpng
```

To create a pdf with all the cards, you can write:

```
nanDECK "c:\my scripts\test01.txt" /createpdf
```

The images are created in the same folder for the script, and for multiple images, a number will be added to the end of the filename. In the 1st example, the images will be named:

```
c:\my scripts\test01_01.png
c:\my scripts\test01_02.png
c:\my scripts\test01_03.png
...
```

In the 2nd example, the file will be named:

```
c:\my scripts\test01.pdf
```

If you leave the *action* parameter empty, the program will only load the script specified in the 2nd parameter.

Keyword wizard

In this program, you can use a wizard for inserting keywords (and specifying all the parameters). In the main editor, if you want to insert a directive, right click on an empty row and a menu appears, with all the keywords, if you click on one entry, the corresponding wizard form will be showed:

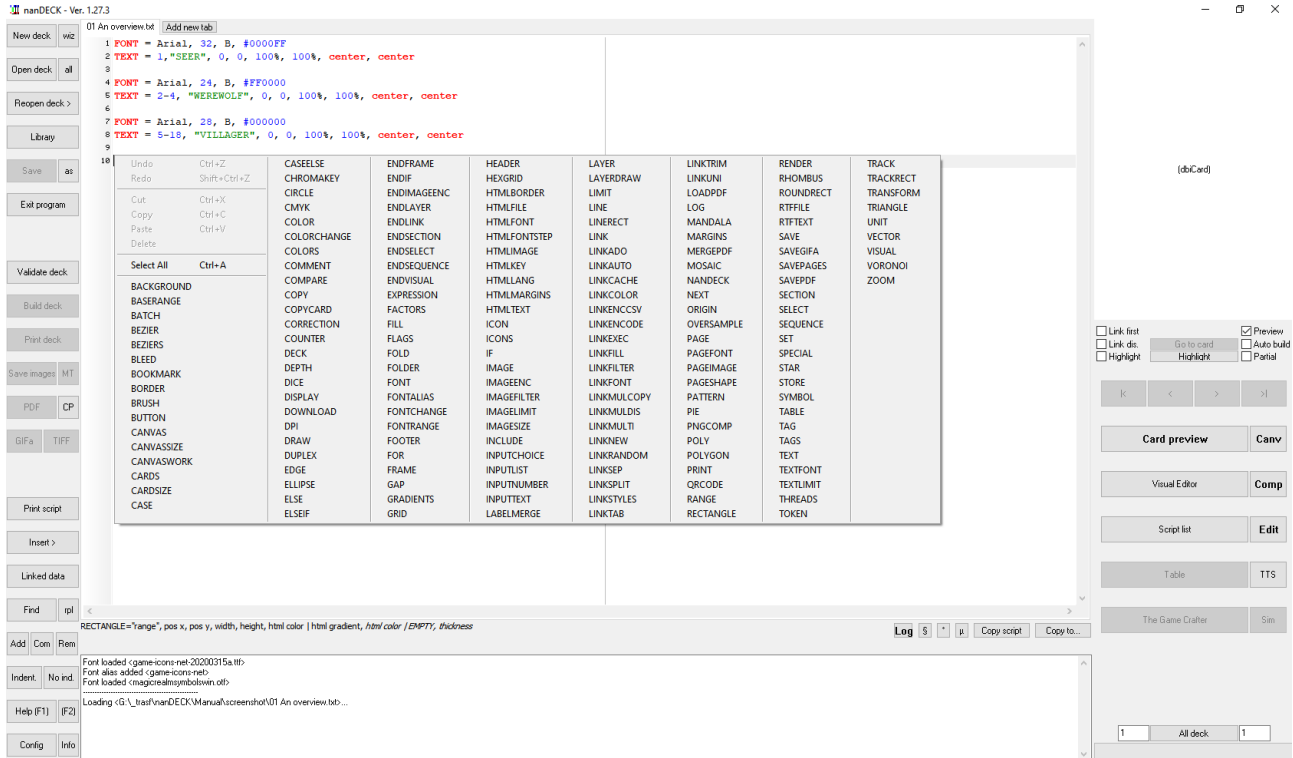

For every keyword, a different wizard form appears, with all the parameters (obligatory and optional). The same window appears if you press “F2” (modify) key on a pre-existent row (or right-click on the same pre-existent row). For example, this is the RECTANGLE wizard form:

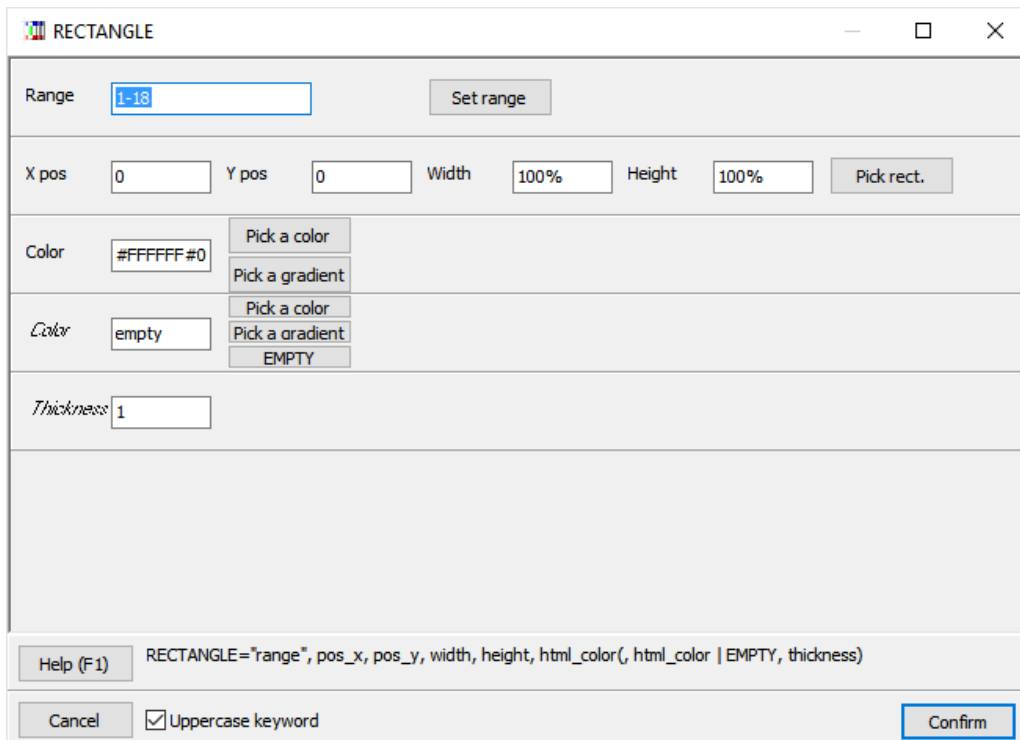

Optional parameters are in *italic* (like *Thickness* in the above form). A hint for the syntax is show in the bottom of the form, with the “**Confirm**”, “**Help**” (it points to the RECTANGLE help page) and “**Cancel**” buttons. For some parameters, there are buttons for inserting specific values (like colors and gradients). For position and size there is a specific form (“**Pick rect.**” Button, in the above form):

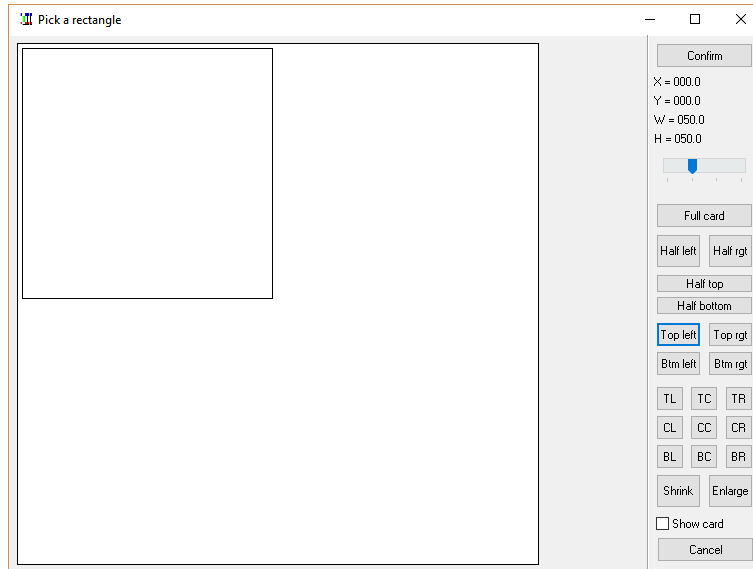

The rectangle can be moved and resized, dragging it with the mouse; you can use the rightmost buttons to change the rectangle size or position into some standard values.

Tip: you can go directly to this form, pressing the key F3 (or clicking the “Visual edit” button) where you are on a line with a graphic directive.

In the wizard form, if you double click in a field, you can choose a label name from a list (you can see also the label’s value):

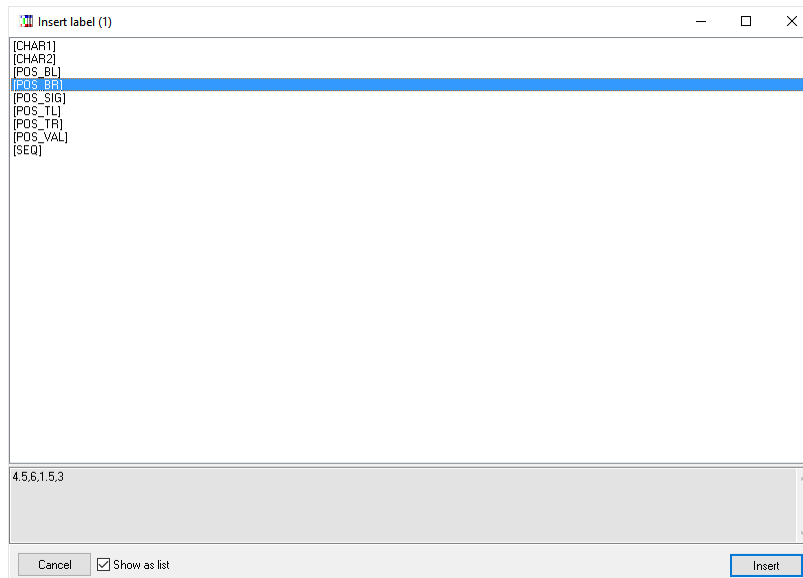

Tip: in every field, you can use the mouse wheel to increase / decrease a numeric value.

Linked data editor

If you use a LINK directive (see page 144) to use a CSV data file, you can edit directly this file using the “Linked data” button. If you click on it, the program shows you a list of linked files. If you choose one of this, a window opens itself, showing you a table with the file content. For example:

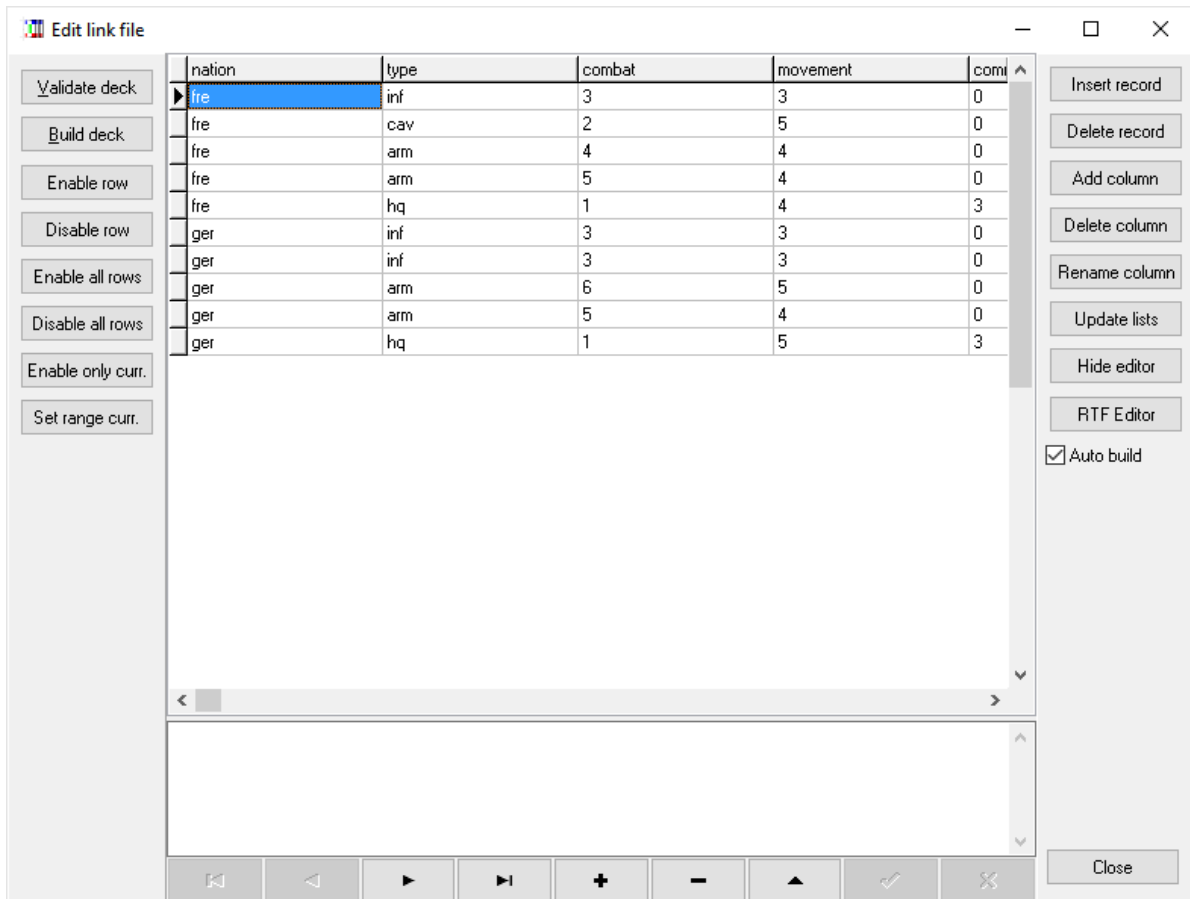

You can modify directly a cell clicking on it (there is a larger edit box on the bottom of the window), you can also change the table' sorting with a click on the column (one click sets an ascending order, another click sets a descending order, it doesn't work for larger fields). With the buttons on the right, you can do some tasks, like insert or delete a record, add, delete, or rename a column (a field), update the lists of data (in the drop-down menu in each field), hide or show the editor, open an external RTF editor (for the current field), or close the window.

The two buttons “Validate deck” and “Build deck” on the left are replicated from the main window. With the other buttons on the left, you enable or disable the current row (putting a ‘ in front of it) or enable or disable all the rows. You can also enable only the current row or setting the range for the deck building. With the buttons on the lower side of the window (under the edit box) you can move the current record (first, previous, next, and last), add (+), delete (-), edit (the triangle), confirm (the check sign) or discard (X) the changes in a record.

All the change made in this window to the linked file will be saved if you save the main script file.

Tip: you can instantly build a single card with a double click on one row of data.

Tip: you can instantly open the external RTF editor with a double click on the lower editor.

Tip: you can select the external RTF in the “Config” button from the main window.

Virtual table

The “Virtual table” option is a desktop in which you can put the result of card rendering, you can use it for saving images for a manual or play test the drawing of cards from a deck. Without modifying your script, you can view the Virtual table clicking on the button “Table” after building a deck. Then you can see a window with your deck in the center of the screen, and you can use these commands:

Mouse commands on decks

click	select deck
double click	draws a card face up
shift double click	draws a card face down
right click	rotate deck 90°
resize	resize deck image
shift resize	resize deck image without keeping size ratio
ctrl resize	resize deck image from the center

Mouse commands on cards/tokens

click	select card
double click	turn card face down/face up – for tokens, recalculate the formula
right click	rotate card 90°
resize	resize card image
shift resize	resize card image without keeping size ratio
ctrl resize	resize card image from the center
mouse wheel	for tokens, select next/previous value or image
ctrl click	pick all the cards and the decks under the cursor and create a new deck
mouse wheel	zoom table

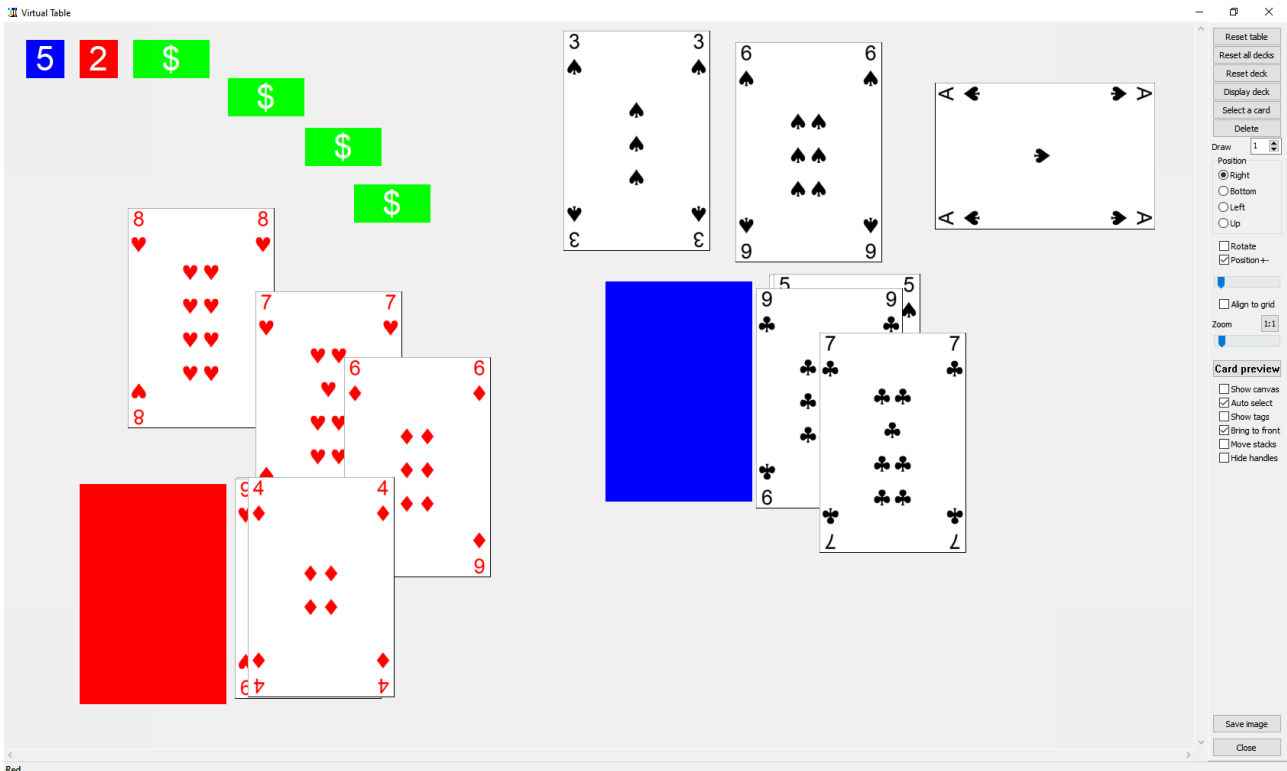

In the bottom line of the window, you can read the number of cards in the selected deck. On the right panel, you have these controls:

Reset table	this button reset to the initial state of all the decks and the elements on the table
Reset all decks	this button reset to the initial state of all the decks

Reset deck	this button reset to the initial state the selected deck
Display deck	this button draws all cards in the deck, and position them left to right, top to bottom in the table
Select a card	this button lets you to select a single card from a deck
Delete	this button deletes the selected object (deck, card, or token)
Draw (number)	the number of cards specified is drawn each time you double click on a deck
Position	the card drawn from the deck is placed to this position, relative to its deck
Rotate	after a card is draw, the position is moved to the next
Position +-	the card drawn is placed in a slightly random direction
Position slider	the amount of the offset of the position when the last option is enabled
Rotate rand.	the rotation of the drawn card is casual
Align to Grid	the card drawn is placed in a grid of the same size of the card
Zoom slider	this slider enlarges or reduce the table size
1:1 button	this button reset the zoom
Card preview	this button show the current card, enlarged
Show canvas	the canvas is shown as a background image
Proportional	the background image from the canvas is proportionally drawn (otherwise is stretched)
Auto select	the elements of the table are selected automatically when the mouse pass over them
Show tags	the tags (see page 180) are shown in the four quadrants of the table
Bring to front	an object clicked is pushed to the front, before all the other objects
Move stacks	when you move a card, all the other cards on top of it are also moved
Hide handles	the handles (for resizing the objects) are not shown
Save image	the table is saved as a bmp file
Close	you close this window

This is the window that the program shows you to select a single card from a deck:

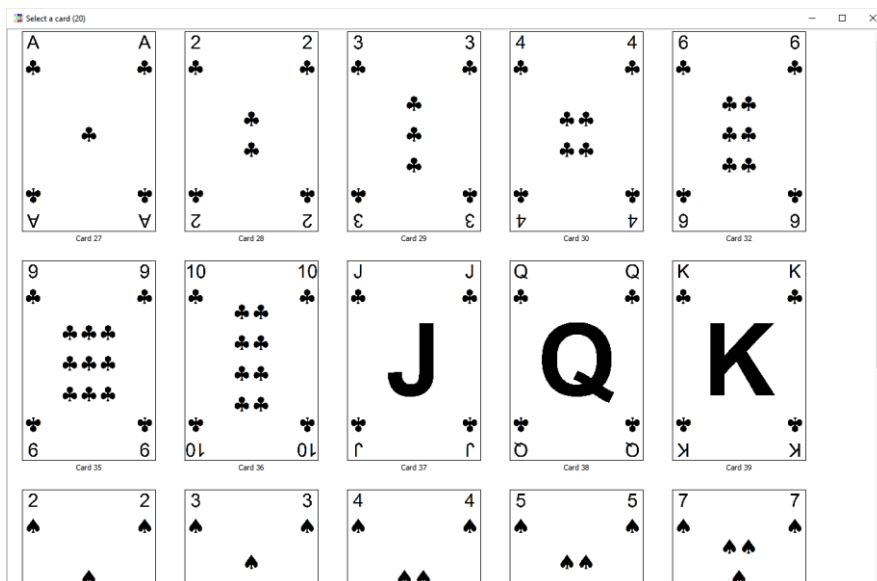

There are two directives that you can use in your script to customize the Virtual table: the DECK directive splits the cards in more than one deck, and the TOKEN directive creates some elements to be used on the table, with a fixed text or a randomized value, in the latter case you can “roll” the token with a double click on it.

Example:

```
...
DECK = "1-26", "Red", #FF0000, 30%
DECK = "27-52", "Black", #0000FF, 30%
TOKEN = "{1d6}", 50, 50, #FFFFFF, #0000FF, 1
TOKEN = "{1d6}", 50, 50, #FFFFFF, #FF0000, 1
TOKEN = "$", 100, 50, #FFFFFF, #00FF00, 10
```

Both in DECK and TOKEN directives you can specify a list of frames for deck/token starting position, another list of frames for the positions in which they can be moved, and a list of rules to be enforced; in this case, you can specify one or more keywords from this list:

MAX1->BLOCK	if the item is moved in a frame already occupied, the moving is blocked
MAX1->PUSHF	if the item is moved in a frame already occupied, the occupying item is moved in the next frame in the list
MAX1->PUSHB	if the item is moved in a frame already occupied, the occupying item is moved in the previous frame in the list
MAX1->DELET	if the item is moved in a frame already occupied, the occupying item is deleted
MAX1->FRAME frm	if the item is moved in a frame already occupied, the occupying item is moved in the frame named frm ; if you specify more than one frame, is used the first free from the list of frames
MAX1->FRAMR frm	if the item is moved in a frame already occupied, the occupying item is moved in the frame named frm ; if you specify more than one frame, is used a random one from the list of frames
DRAW->FRAME frm	when a card is drawn from a deck, is placed in the frame named frm ; if you specify more than one frame, is used the first free from the list of frames
DRAW->FRAMR frm	when a card is drawn from a deck, is placed in the frame named frm ; if you specify more than one frame, is used a random one from the list

Visual editor

You can open the Visual Editor with a click on the “Visual editor” button, or pressing F4 on the keyboard, or by a middle button (or wheel) click on the mouse, this is the main form:

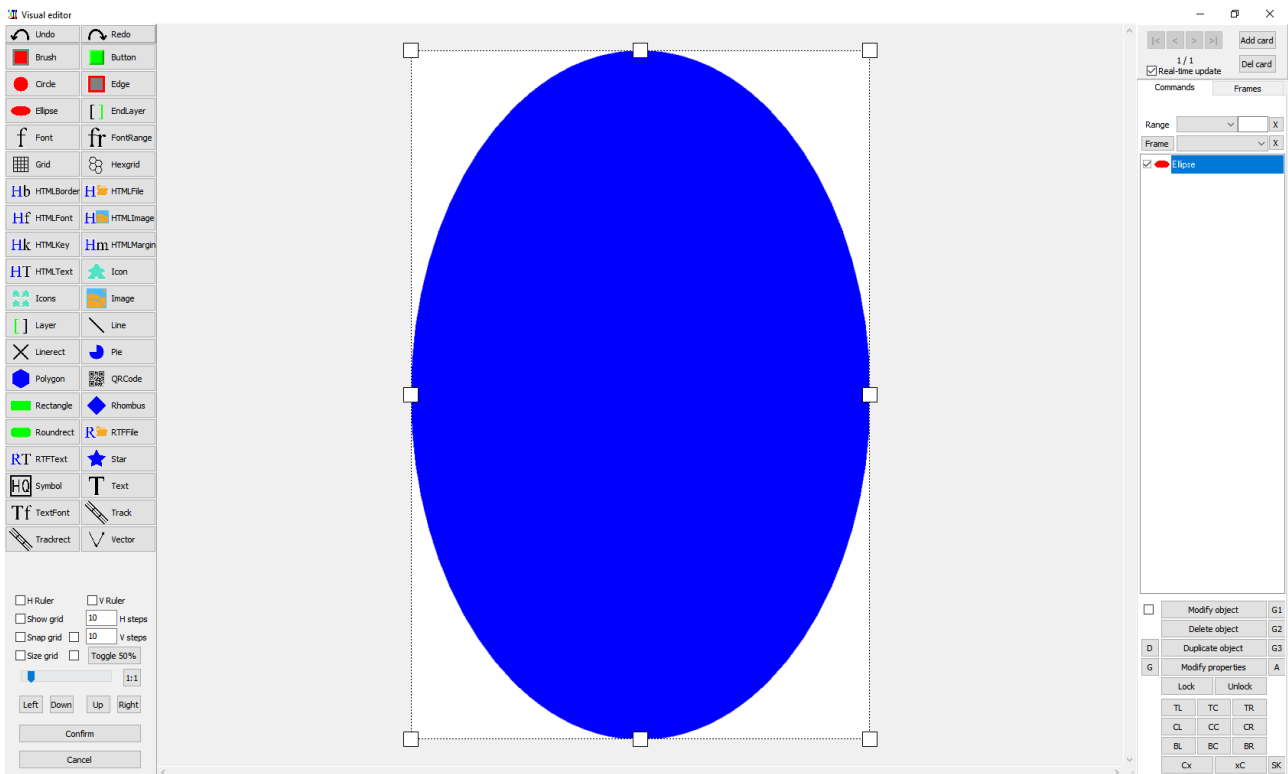

The visual directives are a subset of the standard ones, and are loaded from a section of the source delimited with VISUAL / ENDDISUAL directives, for example:

```
VISUAL
ELLIPSE = 1, 0, 0, 100%, 100%, #0000FF
ENDDISUAL
```

With this script, when you press the “Visual Editor” button, the program loads the lines between VISUAL / ENDDISUAL in the visual GUI, and you can modify them, or add new directives (with the toolbox on the left of the window).

When you press the “Confirm” button, all the objects are inserted in the source, between VISUAL / ENDDISUAL, so there is a two-way interaction between source and GUI (but only in a section of the source). Non-visual directives are not allowed in this section (the program gives an error in the validation step).

If the VISUAL / ENDDISUAL section is not present, the program shows you an empty GUI (but you can add new objects) and when you return to the source, a visual section is added to the end of it.

You can see at the right of the GUI window a list of directives, that will go to the source if confirmed, that are layered from the top (first, to the rear) to the bottom (last, to the front). They can be drag and dropped across the list to change their layer position (the result is shown immediately in the main panel).

At the top right of the window there are some buttons to navigate through the deck (and add or delete cards), a checkbox to enable/disable the real-time update of the current object when you change its parameters (with F2), a combo box for choosing a label / sequence to be inserted in directives like TEXT or IMAGE and another combo box for choosing a sequence to be used with a LABELRANGE function to choose a range (the object is shown only when the item of the sequence is equal to “1”).

The last combo box is when you want to link the object to a frame (only frames defined within VISUAL / ENDDISUAL section are shown); these frames are shown by clicking on the “Frames” tab (all other objects are

locked); in this tab, you can also enable only a group of frames: to define a group you can create frames with a **group/name** syntax (for example: **group1/frame1**, **group1/frame2**, etc.). If you enable the option “Change objects’ frames”, when you choose a group, the program will move all the objects that has frames with compatible names to the new frames.

In the bottom left of the windows there are the controls for showing h/v rulers, a grid (with the number of horizontal and vertical steps) and snap/size to the grid, a slider for zooming in and out the card, a button “Toggle 50%” to toggle on/off 50% transparency to the current object (useful to see what lies beneath), and a button “1:1” for restoring a 100% zoom and four buttons to move the selected object in the four directions (these buttons are linked to the arrows keys on the keyboard).

In the bottom right there are nine buttons, to move the selected element to these positions. If you use the right mouse, the element instead of being moved is resized (for example, the CC button resize it to the whole card). The last two buttons, “Cx” and “xC” centers the element vertically and horizontally, respectively.

Mouse controls:

- right click (on the object and the command in the list): modify the parameters utilized for rendering the object
- double click (on the command in the list): modify properties of an object (comment, lock, group, snap to grid, and size to grid)
- use mouse wheel for zooming the card’s image
- use CTRL + mouse wheel to move between cards

Shortcuts:

F2	modify current object
F3	modify properties of current object
Del	deletes current object
CTRL+Z	undo (button top-left of window)
CTRL+SHIFT+Z	redo (button top-left of window)
CTRL+D	duplicate the current object
CTRL+L	lock the position of the current object
CTRL+U	unlock the position of the current object
CTRL+H	toggle 50% transparency on/off
CTRL+G	toggle snap to grid
CTRL+S	toggle size to grid
CTRL+T	tile all the windows
CTRL+1	assign group “One” to selected object (button G1 bottom-right of window)
CTRL+2	assign group “Two” to selected object (button G1 bottom-right of window)
CTRL+3	assign group “Three” to selected object (button G1 bottom-right of window)
CTRL+SHIFT+1	assign group “One” to all the objects
CTRL+SHIFT+2	assign group “Two” to all the objects
CTRL+SHIFT+3	assign group “Three” to all the objects
CTRL+R	switch group of the selected object to the next (button G bottom-right of window)
CTRL+UP	aligns current group of objects to the top
CTRL+DOWN	aligns current group of objects to the bottom
CTRL+LEFT	aligns current group of objects to the left
CTRL+RIGHT	aligns current group of objects to the right
CTRL+HOME	aligns current group of objects to the center, horizontally
CTRL+END	aligns current group of objects to the center, vertically
CTRL+PGUP	distributes current group of objects horizontally
CTRL+PGDOWN	distributes current group of objects vertically
UP	move the current object up one pixel
DOWN	move the current object down one pixel
LEFT	move the current object one pixel to the left
RIGHT	move the current object one pixel to the right

Configuration

The “Config” button on the main window brings you to the configuration window:

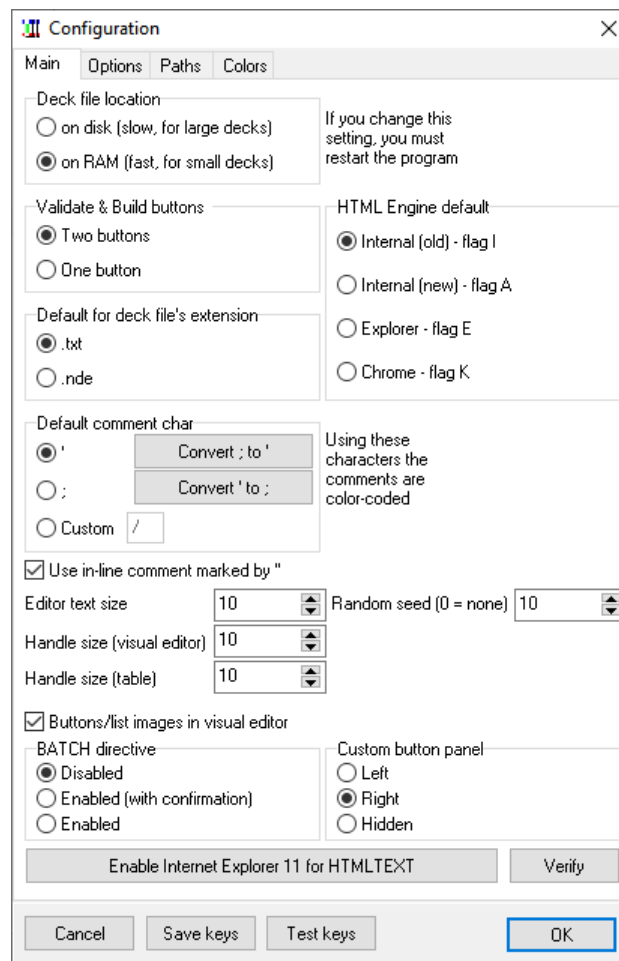

Deck file location: the program can run in two modes, the default “on RAM” setting uses RAM for the card rendering, it is fast, but if you have many high-resolution cards, it can slow down the whole computer (when the RAM is full). Instead, the “on disk” setting is slower, but it can render many high-resolution cards without slowing down your PC. The same is true if you have exceptionally large decks (thousands of cards).

Validate & Build buttons: usually “Validate” and “Build” are two distinct buttons in the main window. With this option, you can have one single button “Validate & Build”; if you click it, the script will be first validated, and if valid, the deck will be built next.

Default for deck file’s extension: with this option, you can choose the default extension between “.txt” and “.nde” (and assigning these files to the nanDECK program and open them with a double click).

HTML Engine default: this option sets the HTML engine used for HTMLTEXT/HTMLFILE directives, if not specified with a flag.

Default comment char: with this option, you can choose the character used for commenting lines, and changing all of them from one to another, you can also use a custom character (instead of the default ‘ and ;).

Use in-line comment marked by ;: if you enable this option, you can use a double comment char for inserting comments on the same line used for commands. For example (with the default “;” comment char):

```
CARDSIZE = 6, 9 ;; default card size
```

Editor text size: this number sets the size of the font for the editor’s character (the default is 10).

Handle size (visual editor): this is the size (in pixels) of the eight white squares that you can use to resize an object in the visual editor.

Handle size (table): this is the size (in pixels) of the eight white squares that you can use to resize an object in the virtual table.

Random seed (0 = none): with this option you can select between a random number generator (if using 0) or a fixed seed (i.e. the sequence of all random numbers is always the same).

Buttons/list images in visual editor: if enabled, the buttons and the list of objects in the visual editor has an icon, depicting the related object.

BATCH directive: for security reason the BATCH directive (see page 87) must be enabled before use, selecting an option from “Disabled”, “Enabled (with confirmation)”, and “Enabled”.

Custom button panel: the panel showing the button associated with shortcuts can be shown to the left or to the right of the main editor, or hidden.

Enable Internet Explorer 11 for HTMLTEXT / HTMLFILE: as a default a program cannot use Internet Explorer features beyond version 6, until there is a specific entry in Windows’ Regedit; by using this button the program writes that correct entry.

Verify: Shows the status of the previous option.

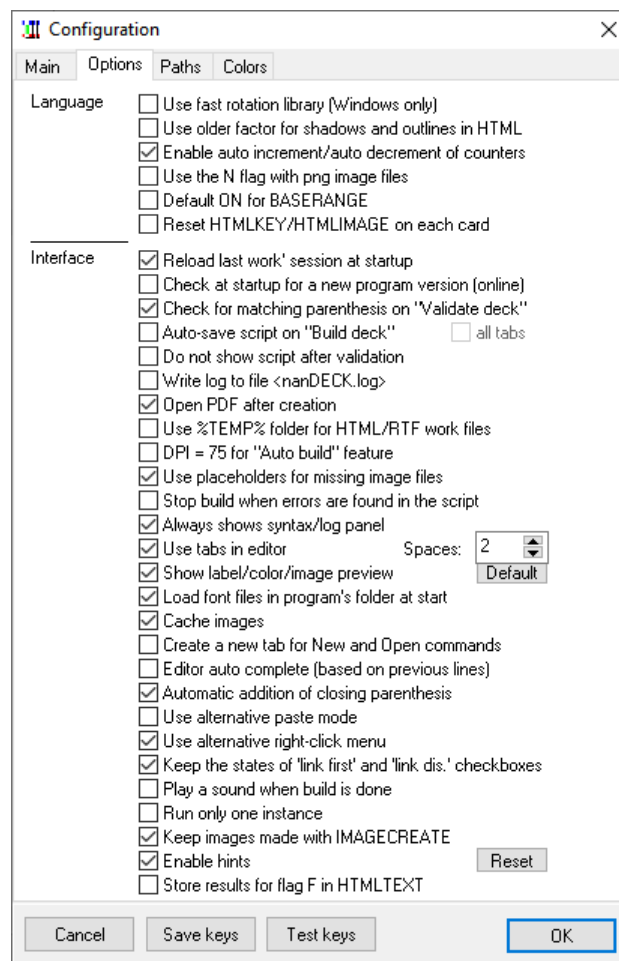

Use fast rotation library (Windows only): use an alternative rotation library that uses routines available only on Windows (when the program is executed for the first time on Wine, this option is unchecked).

Use older factor for shadows and outlines in HTML: when they were first implemented, shadows and outlines with HTMLFONT use a value for size that was not correct; now it is fixed, but if you want to use the older routines, check this option.

Enable auto-increment/auto-decrement of counters: with this option enabled, you can use numbers before or after counters to add/subtract a number from them (if before, the number is added/subtracted before using the counter, if after, the addition/subtraction occurs after having used the counter).

Use the N flag with png image files: if enabled, every png image file loaded with directives ICONS (see page 129), IMAGE (see page 132), and PATTERN (see page 162) has the N flag (to use the transparency layer info).

Default ON for BASERANGE: if enabled, the default value for BASERANGE is ON instead of OFF (see page 86).

Reset HTMLKEY/HTMLIMAGE: with this option enabled, these directives are deleted when switching to the next card; if disabled, they are retained between cards.

Reload last work' session at startup: with this option enabled, at the start the program loads the file(s) opened in the last session.

Check at startup for a new program version (online): with this option enabled, at the start the program checks online if a new release is available for the download and warns you in the window's title.

Check for matching parenthesis on "Validate deck": with this option enabled, the program checks if the parenthesis match in all your script.

Auto-save script on "Build deck" command: with this option enabled, the program always saves the script when you click on the "Build deck" button; the checkbox "all tabs" does the auto-save option for all the editor tabs.

Do not show script after validation: usually the program, after the validation procedure, writes the script in the lower box in the main window. With this option enabled, the script is not written (speeding up the validation process).

Write log to file <nandeck.log>: with this option enable, you can save the program log (all the text shown in the lower box in the main window) in a text file.

Open PDF after creation: with this option enabled, after a PDF is created, the program opens it, using the default application associated with ".pdf" extension.

Use %TEMP% folder for RTF/HTML work files: these directives create a temporary file, if you enable this option that file will be create in the temporary folder, if you disable this option, it will be created in the current folder. Note that if you have projects in folder linked to a cloud service (like Dropbox™) you should enable this option.

DPI = 75 for "Auto build" feature: if you have enabled the "Auto build" option, if this option is enabled, the preview is done at a lower resolution (useful for slow PC).

Use placeholders for missing image files: if you specify file images that does not exists, the program creates them (a random color bitmap with the name of the file repeated on it) and shows you in a window the list of the missing files.

Stop build when errors are found in the script: with this option enabled, the validate procedure is stopped when an error is found in the editor, if it is disabled, the line with errors are highlighted and the validation is completed.

Always shows hint panel: with this option enabled the bottom panel with the keyword's help is shown always, and not only when a keyword is present in the current editor line.

Use tabs in editor: if you enable this option, each tab key is converted to the specified number of spaces.

Show label/color/image preview: with this option enabled, when the caret is on a label, its content (text, color, or image) is shown in the lower part of the main window (the Default button resets the standard widths of these resizable panels).

Load font files in program's folder at start: if this option is enabled, nanDECK, when it is started, loads all the font files that are found in the same folder with its executable.

Cache images: with this option enabled, all the files loaded with an IMAGE directive are stored in RAM, for a faster reload; if you need more RAM for your deck, uncheck this option.

Create a new tab for New and Open commands: if this option is enabled, when you create a new script or load an existing one, a new editor tab is created, instead of executing that command in the existing editor tab.

Editor auto complete (based on previous lines): if this option is enabled, when you digit some characters, if an existing line is already present in the editor, that starts with these characters, is proposed as selected text.

Automatic addition of closing parenthesis: if this option is enabled, when you digit an open parenthesis (standard, square, or curly) the corresponding closing parenthesis is automatically added.

Use alternative paste mode: if you are unable to paste text in the editor, try this alternative method for the clipboard.

User alternative right-click menu: with this option enabled, the right-click on a directive line open the keyword list instead of the keyword editor (note that you can always have the non-selected option with a CTRL+right click).

Keep the states of 'link first' and 'link dis.' checkboxes: note that usually these two checkboxes are not saved between sessions (i.e., closing, and reopening nanDECK do not restore their state).

Play a sound when build is done: when the program has completed the building of a deck, the default "beep" sound is played.

Run only one instance: if enabled, the program shows you an error message when you start another instance of it.

Keep images made with IMAGECREATE: if enabled, the images made with IMAGECREATE are not deleted at the end of the build but saved for later builds.

Enable hits: if enabled, a suggestion is shown when the use of certain keywords is found.

Store results for flag F in HTMLTEXT: if enabled, all values obtained with the F flag in HTMLTEXT are recorded in a file with the same name as the current script and the extension .precomp, to speed up subsequent execution.

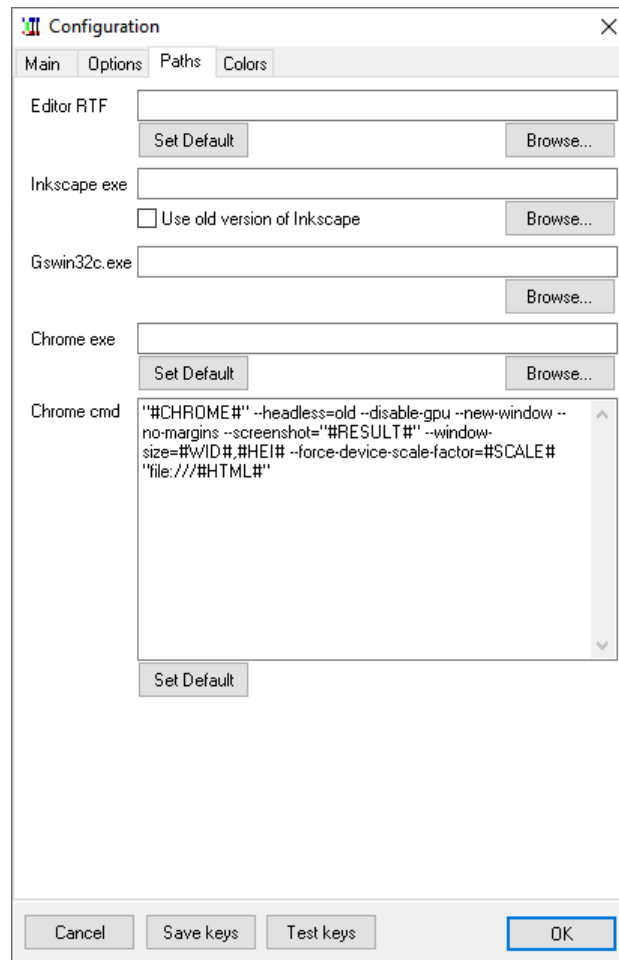

Editor RTF: this is the path to the executable file called when you want to edit a field text in a linked file with an external RTF editor. You can also choose the default executable linked with an “.rtf” file extension.

Inkscape exe: this is the path to the executable file for Inkscape, used with the VECTOR directive (see page 189) when you want to use it for the rendering, instead of the internal engine (the default, less accurate); the checkbox is used if you have installed an old version of Inkscape.

Gswin32c.exe: this is the path to the executable file for Ghostscript, used with the directive LOADPDF (see page 153) when you want to use it for reading PDF files, instead of the internal engine (the default, less compatible).

Chrome exe: this is the path to the executable file called when you use the K flag in HTMLTEXT (see page 127).

Chrome cmd: the command line used to invoke Chrome when you use the K flag in HTMLTEXT (see page 127).



Editor text color, Editor background color, Editor highlighter color, Editor structures color, Editor text error, Editor background error, Editor string color, Editor number color, Editor keyword color, Editor comment color, Brackets text, Brackets match, Gutter text color, Gutter color start, Gutter color end: with these buttons, you can change the default colors for the editor text, background, highlighted line, lines that contain special directives, text and background for lines that contain errors, specific parts of the script, brackets, and the gutter (i.e. the left column in the editor), and re-setting them to the default values by pressing the **Default** button; you can invert them with the **Reverse** button.

Copy to BGG: you can change the default color for copying the current script into a post on BoardGameGeek’s forums.

Save keys: the program saves a “keys.txt” file, that contains the shortcuts for several actions, if you want to change them modify this file (with an editor) and restart nanDECK.

Test keys: This command is useful when you want to know the code of a particular key combination, to be used for the above feature.

Compare decks

When you have loaded more than one deck (adding another tab with CTRL+N) you can view them side to side by clicking on the “Comp” button in the right side of the main window:

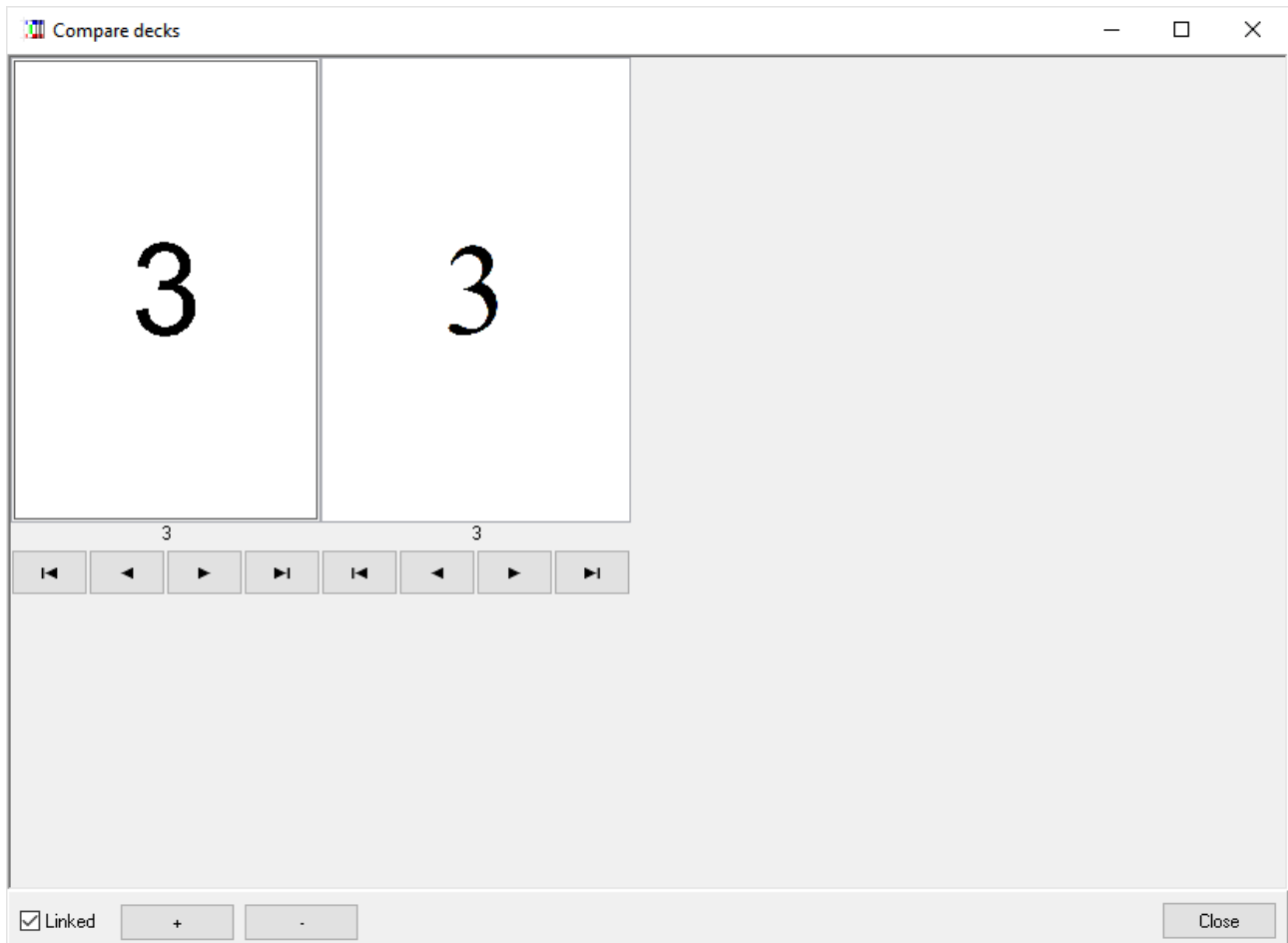

You can browse the decks with the arrow buttons (linked by default, but you can remove this feature with the “Linked” checkbox) and you can zoom in or out with the two buttons “+” and “-”.

Shortcuts

At the start, nanDECK reads a **shortcuts.txt** file from the same folder, and creates shortcuts for every line read (or combinations of lines). You can recall these clips of text with combinations of keys like **Ctrl + Alt + *letter*** or **Ctrl + Alt + Shift + *letter***. The lines associated with the *letter* character, lower or uppercase, (identified before a “:” colon) are inserted in the main editor (in the current edit position).

For example, if you have this **shortcuts.txt** file (created with Notepad or another text editor):

```
r:RECTANGLE = 1, 0, 0, 100%, 100%, #0000FF
T:FONT = ARIAL, 32, , #000000
TEXT = 1, "Test", 0, 0, 100%, 100%
```

You can press **Ctrl + Alt + r** for the RECTANGLE line or **Ctrl + Alt + Shift + t** for the FONT + TEXT lines.

F.A.Q.

1) When must I use quotes (““)?

This program uses an interpreter for the evaluation of all parameters, this code separates them using commas (.). So, if a parameter has a comma in it, you must enclose the parameter in quotes. Otherwise, if a parameter has no commas, the quotes are optional (the program will accept the parameter with or without quote), but for some parameter quotes are an error (for numeric parameters, for example).

Correct examples:

```
IMAGE = "1-10", "c:\my images\earth.jpg", 0, 0, 6, 9, 0
IMAGE = 1-10, c:\my images\earth.jpg, 0, 0, 6, 9, 0

TEXT = 1-10, "This, is a test", 0, 0, 6, 9
```

Note: quotes in ranges are not needed.

Wrong example:

```
TEXT = 1-10, This, is a test, 0, 0, 6, 9
```

The 2nd parameter will be split into “This” for 2nd parameter and “is a test” for 3rd.

2) How can I insert quotes (or another character) in a text?

You can use `\n` syntax to insert a character in a text, with `n` being the ASCII code of that character, for example, if you want to enclose a text in quotes (ASCII 34) or add a new line (ASCII 13):

```
FONT = Arial, 32, , #000000
TEXT = 1, "I say \34\Hello\34\"", 0, 0, 6, 9, center, center
```

Note that `\13\` works with TEXT directive, instead with HTMLTEXT you must use the HTML tag `
`.

3) Why this program uses so much memory?

This program has two settings for storing cards during creation: RAM or disk. The default setting is in RAM, and you can change that in the “Config” window, remember that RAM is faster (and you can run multiple instances of the program) but the computer may slow down when it starts using swap space; on disk is slower (and you can’t run multiple instances) but the speed remains the same even with very large decks (or higher DPI settings).

4) Why there is option (X) if you can use (Y)?

When writing this program, I tried to maintain backward compatibility with previous version, so you can do the same thing in more than one way. For example: WWTOP option for vertical alignment in TEXT command is equal to CENTER, for backward compatibility.

5) There is a Linux version?

No, but if you install Wine, you can run the same nanDECK version for Windows on your Linux, with all the major features; also, if you want better compatibility, you can download and install the “Microsoft core fonts”.

Wine <http://www.winehq.org/>
Microsoft core fonts <http://sourceforge.net/projects/corefonts/files/the%20fonts/>

Note: with a recent update, nanDECK uses a DLL (FONTSUB.DLL) that is not present in every distribution, if this is the case the program will not start, you must download a zip that includes this file from here:

http://www.nand.it/nandeck/nandeck_wine.zip

6) There is a Mac version?

No, but if you install Winebottler (and XQuartz) you can run the same nanDECK version for Windows on your OSX, with all the major features. You can also use an emulator like Virtual Box (free) or Parallels (commercial software).

Winebottler <http://winebottler.kronenberg.org/>
XQuartz <http://xquartz.macosforge.org/>

Note: with a recent update, nanDECK uses a DLL (FONTSUB.DLL) that is not present in every distribution, if this is the case the program will not start, you must download a zip that includes this file from here:

http://www.nand.it/nandeck/nandeck_wine.zip

Directives

BACKGROUND

This directive draws an image using gradients created from colors read from rectangular or circular areas (specified by frames, see page 47). For this directive you can use frames defined with the standard syntax, or use this special syntax:

<frame>=x, y, width, height, special

The *special* parameter can be composed of one or more colors, defined with one of these syntaxes:

#000000 is a color,

#000000%A is a color where **A** is the % distance from the original frame,

#000000%A\$B is a color where **A** is the % distance from the original frame and **B** is a factor used to calculate the weight of this color.

If you add a @ symbol to the end of the special parameter the color changes will be made from a circular shape rather than a rectangular one. If you add a ! symbol to the start of the special parameter the background is drawn also inside this shape.

Syntax:

BACKGROUND = "range", pos x, pos y, width, height, frames, *flags*, *width*, *red*, *green*, *blue*

"range": a set of cards

pos x: horizontal position (in cm)

pos y: vertical position (in cm)

width: width of the rectangle (in cm)

height: height of the rectangle (in cm)

frames: the name of the frame(s) used for reading the colors

flags: one or more of the following flags:

- E the distances are measured using an "Euclidean" formula (square root and powers), this is the default
- M the distances are measured using a "Manhattan" formula (absolute differences)
- S the variation specified with red/green/blue parameters is applied when there are more than half distances between the frames that are greater than the parameter distance
- I the color variation specified with red/green/blue parameters is applied when there are less than half distances between the frames that are greater than the parameter distance
- N the color variation specified with red/green/blue parameters is applied when the number of distances between the frames that are greater than the parameter distance is an even number
- O the color variation specified with red/green/blue parameters is applied when the number of distances between the frames that are greater than the parameter distance is an even number

distance: the distance used with flags S, I, N, and O

red: the variation (positive or negative) of the red component used with flags S, I, N, and O

green: the variation (positive or negative) of the green component used with flags S, I, N, and O

blue: the variation (positive or negative) of the blue component used with flags S, I, N, and O

BASERANGE

For each card in a range an element is extracted from a sequence, and as a default the first element from the sequence is paired from the first card in the range. The only exception is when you have a LABELRANGE function (see page 37): in this case, the nth element from the sequence is paired with the nth card from the deck. With this directive, you can change this behavior.

Syntax:

BASERANGE = “range”, switch

Parameters:

“**range**”: a range of cards

switch: values accepted are:

ON the n^{th} element from the sequence is paired with the n^{th} card from the deck
OFF the n^{th} element from the sequence is paired with the n^{th} card from the range

BATCH

This directive executes an external batch script (a text file with a “.bat.” extension). For security reasons, you must enable the relative option in the Configuration form: here you can choose between “Disabled”, “Enabled (with confirmation)”, and “Enabled”. The batch file is called with these parameters:

%1 the current card’s number
%2 the total number of cards in the deck
%3 the name of the script

Syntax:

BATCH = “batch file”, *flags*

Parameters:

“**batch file**”: path and name for a batch file

flags: one or more of the following flags:

V the batch is executed at the validation step (the default, if not specified)
S the batch is executed at the start of the build step
C the batch is executed at the end of each built card
E the batch is executed at the end of the build step

Example:

```
BATCH = "c:\bat\copy_files.bat"
```

BEZIER

This directive draws a Bezier curve from a starting point (x1, y1) to an ending point (x2, y2), using two “handles” (h1 and h2).

Syntax:

BEZIER = “range”, pos x1, pos y1, handle x1, handle y1, handle x2, handle y2, pos x2, pos y2, html color, *thickness*, *end arrow*, *start arrow*, *end angle*, *start angle*

Parameters:

“**range**”: a set of cards

pos x1, **pos y1**: coordinates of starting point (in cm)

handle x1, **handle y1**: coordinates of handle for starting point (in cm)

handle x2, **handle y2**: coordinates of handle for ending point (in cm)

pos x2, pos y2: coordinates of ending point (in cm)

html color: color of the curve, in the same format used for HTML, you can also specify a gradient

thickness: thickness of the curve (in cm), if omitted, the curve is 1 pixel wide

end arrow: width of the arrow (in cm), if omitted (or zero) there is no arrow at the end of the curve

start arrow: width of the arrow (in cm), if omitted (or zero) there is no arrow at the start of the curve

end angle: the angle (in degrees) of the spokes of the arrow at the end of the curve

start angle: the angle (in degrees) of the spokes of the arrow at the start of the curve

Note: if end/start angle is negative, the arrow is drawn as a full triangle (with three lines instead of two).

Example:

```
BEZIER = 1, 1.5, 0, 1.5, 4.5, 4.5, 4.5, 4.5, 9, #0000FF, 0.15
BEZIER = 1, 4.5, 0, 4.5, 4.5, 1.5, 4.5, 1.5, 9, #0000FF, 0.15
BEZIER = 1, 0, 3, 3, 3, 3, 6, 6, 6, #FF0000, 0.15
BEZIER = 1, 0, 6, 3, 6, 3, 3, 3, 6, 3, #FF0000, 0.15
```

Result: Figure 11

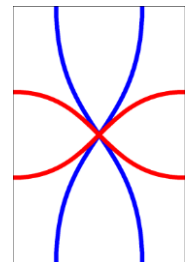

Figure 11

BEZIERS

This directive draws a Bezier curve from a starting point (from the last BEZIERS directive) to an ending point (x, y), using two “handles” (one from the last directive and one from parameter h). The first directive sets only the starting point, for each subsequent directive a curve is drawn (the starting point for the next curve is the ending point of the last). For restarting the process, you can specify a BEZIERS with only the range parameter.

Syntax:

BEZIERS = “range”, pos x, pos y, handle x, handle y, html color, thickness, end arrow, start arrow, end angle, start angle

Parameters:

“range”: a set of cards

pos x, pos y: coordinates of starting/ending point (in cm)

handle x, handle y: coordinates of handle for starting/ending point (in cm)

html color: color of the curve, in the same format used for HTML, you can also specify a gradient

thickness: thickness of the curve (in cm), if omitted, the curve is 1 pixel wide

end arrow: width of the arrow (in cm), if omitted (or zero) there is no arrow at the end of the curve

start arrow: width of the arrow (in cm), if omitted (or zero) there is no arrow at the start of the curve

end angle: the angle (in degrees) of the spokes of the arrow at the end of the curve

start angle: the angle (in degrees) of the spokes of the arrow at the start of the curve

Note: if end/start angle is negative, the arrow is drawn closed (with three lines).

Example:

```
BEZIERS = 1, 0, 0, 3, 0, #000000, 0.1
```



```
BEZIERS = 1, 0, 3, 3, 3, #FF0000, 0.1, 0.5
BEZIERS = 1, 0, 6, 3, 6, #00FF00, 0.1, 0.5
BEZIERS = 1, 0, 9, 3, 9, #0000FF, 0.1, 0.5
Result: Figure 12
```

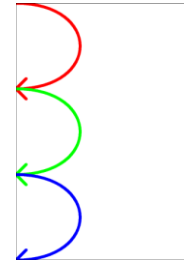

Figure 12

BLEED

This directive fills the space beyond a rectangle with the colors from the border of the rectangle, if you do not specify the size of the outer rectangle, this directive fills the whole card.

Syntax:

BLEED = “range”, pos x1, pos y1, width1, height1, pos_x2, pos_y2, width2, height2

Parameters:

“range”: a set of cards

pos x1: horizontal position (in cm)

pos y1: vertical position (in cm)

width1: width of the rectangle (in cm)

height1: height of the rectangle (in cm)

pos x2: horizontal position (in cm) of the outer rectangle

pos y2: vertical position (in cm) of the outer rectangle

width2: width of the outer rectangle (in cm)

height2: height of the outer rectangle (in cm)

Examples:

```
BLEED = "1-10", 1, 1, 4, 7
```

```
BLEED = "1-10", 1, 1, 4, 7, 0.5, 0.5, 5, 6
```

BOOKMARK

This directive adds the referred bookmark (from 0 to 9) to the current line in the editor (or another, if the *offset* parameter is specified, positive toward the end, negative toward the start). Note that you can go to a bookmark line with CTRL+(0..9).

Syntax:

BOOKMARK = number, *offset*

Parameters:

number: the number of the bookmark, from 0 to 9

offset: this value is added to the current line in the editor

These bookmarks are automatically added in the validation step at the 1st instance of each directive:

```
#1    PAGE
#2    CARDSIZE
#3    LINK
#4    VISUAL
```

BORDER

This directive draws a border around all the cards.

Syntax:

BORDER = *type, html color, thickness, guidelines, guide color, mark/cross/line size, hor. guide offset, ver. guide offset, num. of guides, hor. gap offset, ver. gap offset, thickness*

Parameters:

type: the type of border can be chosen between:

RECTANGLE	draws a rectangle (the default)
ROUNDED	draws a rectangle with rounded corners
MARK	draws cut marks (the length is set with the 6 th parameter)
NONE	no border

html color: color of the border, in the same format used for HTML, black if not specified

Note: if you want a different border color on each card, use instead RECTANGLE or ROUNDRECT, with the internal color as EMPTY.

thickness: thickness of the border (in cm), if omitted, it is 1 pixel wide

Note: the thickness of the border is measured on two cards; if you use a thickness of 1 cm, for example, on each card the border is 0.5 cm wide.

guidelines: this is for drawing lines beyond the card's boundaries (over the page's margins); you can choose between:

NONE	no guidelines (the default)
SOLID	solid lines
DOTTED	dotted lines
DASHED	dashed lines
MARK	draws cut marks only (solid lines)
MARKDOT	draws cut marks only (dotted lines)
MARKDASH	draws cut marks only (dashed lines)
CROSS	draws cut marks and crosses (solid lines, the length is set with the 6 th parameter)
CROSSDOT	draws cut marks and crosses (dotted lines, the length is set with the 6 th parameter)
CROSSDASH	draws cut marks and crosses (dashed lines, the length is set with the 6 th parameter)
LINE	draws cut marks and lines (solid lines, the length is set with the 6 th parameter)
LINEDOT	draws cut marks and lines (dotted lines, the length is set with the 6 th parameter)
LINEDASH	draws cut marks and lines (dashed lines, the length is set with the 6 th parameter)

guide color: color of the guidelines, in the same format used for HTML, black if not specified; If multiple guides are specified in the 9th parameter, multiple colors can be indicated here

mark/cross/line size: length of the cut marks (in cm) for MARK border type, length of the arm of the cross (in cm) for CROSS/CROSSDOT/CROSSDASH guideline type, length of the line (in cm) outside the card for LINE/LINEDOT/LINEDASH guideline type

hor. guide offset: horizontal guides are displaced of an offset (in cm), zero if not specified

ver. guide offset: vertical guides are displaced of an offset (in cm), equal to horizontal offset if not specified

num. of guides: number of guides drawn (0 means a single line)

hor. gap offset: a gap in horizontal marks (in cm), if zero (or not specified) the mark starts at the cards

ver. gap offset: a gap in vertical marks (in cm), if zero (or not specified) the mark starts at the cards

thickness: thickness of the guideline (in cm), if omitted, it is 1 pixel wide

Note: the result of the BORDER directive is not displayed when the card is saved with SAVE, in this case it is better to use a RECTANGLE or ROUNRECT directive.

Examples:

BORDER = RECTANGLE

BORDER = ROUNDED, #0000FF, 0.5

BRUSH

This directive changes the style used for filling the shapes in these directives:

CIRCLE
ELLIPSE
FILL
HEXGRID
PIE
POLYGON
RECTANGLE
RHOMBUS
ROUNDRECT
STAR
TRIANGLE

Syntax:

BRUSH="range", type, "*image file*", width, height, flags

Parameters:

"range": a set of cards

type: you can choose a type between these options:

SOLID	draws a solid fill (the default)
DIAGLEFT	fills with lines, drawn diagonally from top right to bottom left
DIAGRIGHT	fills with lines, drawn diagonally from top left to bottom right
SQUARE	fills with squares
CROSS	fills with squares, rotated 45°
HORIZONTAL	fills with lines, drawn horizontally
VERTICAL	fills with lines, drawn vertically
CUSTOM	fills with an image

"image file": the image file used for filling the shapes

width: width of the image, in cm

height: height of the image, in cm

flags: one or more of the following flags:

A	absolute position of the custom bitmap (relative to the card), the default
R	relative position of the custom bitmap
T	use the transparent color defined with CHROMAKEY
P	proportional

Examples:

BRUSH="1-10", SQUARE

```
BRUSH="1-10", CUSTOM, "dots.gif", 5%, 5%
```

BUTTON

This directive draws a 3D rectangle over a set of cards. This directive works only if you have previously drawn something in the specified area.

Syntax:

```
BUTTON = "range", pos x, pos y, width, height, depth, flags
```

Parameters:

"range": a set of cards

pos x: horizontal position (in cm)

pos y: vertical position (in cm)

width: width of the rectangle (in cm)

height: height of the rectangle (in cm)

depth: width of the 3D border

flags: one or more of the following flags:

I from out to in
O from in to out
G gradient effect

Example:

```
RECTANGLE = 1, 1, 1, 4, 3, #00FFFF  
RECTANGLE = 1, 1, 5, 4, 3, #00FFFF  
BUTTON = 1, 1, 1, 4, 3, 0.3, I  
BUTTON = 1, 1, 5, 4, 3, 0.3, O
```

Result: Figure 13

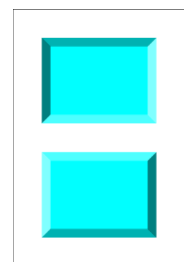

Figure 13

CANVAS

With this directive, the program splits the canvas (card 0) onto a range of cards. The canvas' size can be decided with a CANVASSIZE directive (see page 93).

Syntax:

```
CANVAS = "range", flags
```

Parameters:

"range": a set of cards

flags: in this parameter you can specify a special behavior, possible values are:

H the canvas is horizontally centered in the cards
V the canvas is vertically centered in the cards

Tip: You can view the content of the canvas bitmap with a click on the button "Canv" (to the right of the "Card preview" button). You can reduce/enlarge it with a double-click on the image.

For example, if you must draw a large circle, to be split onto six cards, you can use the CANVASSIZE/CANVAS directives, like in this script:

```
BORDER = MARK
CANVASSIZE = 18, 18
CANVAS = 1-6
ELLIPSE = 0, 0, 0, 18, 18, #0000FF#FF0000@360
FONT = Arial, 48, , #000000
TEXT= 1-9, {$}, 0, 0, 2, 2, CENTER, CENTER
```

This is the resulting printed page (I have added a number in the top-left corner of each card for helping identify them):

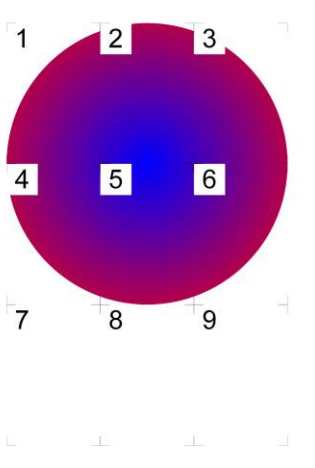

CANVASSIZE

This directive sets the size of the canvas (card number 0). If omitted, is 6 cm x 9 cm. The card 0 is a card that isn't printed with the deck, is can have a different size than the standard card and can be used in two ways: as a drawing board to realize special effects, and to draw a larger card that must be split onto several standard cards, using the CANVAS directive (see page 92).

Syntax:

CANVASSIZE = width, height

Example:

```
CANVASSIZE = 12, 18
```

CANVASWORK

This directive tells the program to draw the canvas (card 0) after drawing the range of cards specified in the parameter.

Syntax:

CANVASWORK = "range"

Parameters:

"range": a set of cards

CARDS

This directive can be used to specify the total number of cards that compose the current deck.

Syntax:

CARDS = number

This directive is somehow obsolete, if you do not specify it, the total number of cards is deducted from the other directives. For example, in that script the total number of cards is set to 20:

```
RECTANGLE = "1-5,15-20", 0, 0, 6, 9, #00FF00
```

But, if you also specify a CARDS directive, the cards' number is forced. For example, in that script the total number of cards is set to 15 (and the extra cards specified in RECTANGLE are ignored):

```
CARDS = 15  
RECTANGLE = "1-5,15-20", 0, 0, 6, 9, #00FF00
```

CARDSIZE

This directive sets the size of cards (in cm). If omitted, is 6 cm x 9 cm.

Syntax:

CARDSIZE = width, height

Examples:

```
CARDSIZE = 5, 10
```

```
CARDSIZE = 2.5, 2.5
```

CASE

This directive is used in a structure SELECT...ENDSELECT to specify a code that must be executed when the value in the SELECT is equal to a specific value (see page 174).

Syntax:

CASE = value

Parameters:

value: a string, number, label, or expression that can be evaluated

CASEELSE

This directive is used in a structure SELECT...ENDSELECT to specify a code that must be executed only if all the CASEs directives are not executed (see page 174).

Syntax:

CASEELSE

Parameters:

None

CHROMAKEY

This directive sets the color to be treated as transparent during image loading with IMAGE directive (see page 132) or with LAYER directive (see page 140). The default transparent color, if CHROMAKEY was not used, is the color in the top-left pixel of the image. You can specify a single color/type or a sequence of colors/types (separated by a pipe "|"), same for *level* parameter.

Syntax:

CHROMAKEY = html color | corner type, *level*

Parameters:

corner type: the color will be picked from one of the four corners, or from the center of the image, or this option can be deactivated:

TOPLEFT
TOPRIGHT
BOTTOMLEFT
BOTTOMRIGHT
CENTER
NULL

level: if specified, are treated as transparent also the colors within a level of difference from the base transparent color (calculated as a distance in CIELab space).

Examples:

```
CHROMAKEY = #FFFFFF
```

```
CHROMAKEY = TOPLEFT
```

CIRCLE

This directive draws a circle in a set of cards.

Syntax:

```
CIRCLE = "range", pos x, pos y, width, height, html color, html color, thickness
```

Parameters:

"range": a set of cards

pos x: horizontal position (in cm)

pos y: vertical position (in cm)

width: width of the circle (in cm)

height: height of the circle (in cm)

html color: border color of the circle, in the same format used for HTML, you can also specify a gradient

html color: inner color of the circle, in the same format used for HTML, if not specified the inner color is the same of border color. You can also specify "EMPTY" for a hollow circle or a gradient

thickness: thickness of the border of the circle (in cm), if omitted, the circle's border is 1 pixel wide

Examples:

```
CIRCLE = 1, 1, 1, 4, 7, #00FF00
```

Result: Figure 14

```
CIRCLE = 1, 1, 1, 4, 7, #FF00FF, EMPTY, 0.1
```

Result: Figure 15

```
ELLIPSE = 1, 1, 1, 4, 7, #FF0000#0000FF@90
```

Result: Figure 16

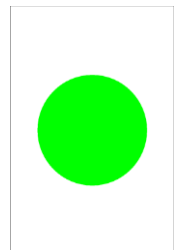

Figure 14

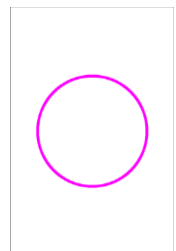

Figure 15



Figure 16

CMYK

This directive modifies the color space of JPG/JPEG images saved with a SAVE directive (see page 171).

Syntax:

CMYK = “range”, switch, *color profile*, *color space*

Parameters:

“range”: a set of cards

The *switch* parameter can be set equal to:

ON to use the CMYK color space when a JPG/JPEG file format is specified
OFF to use the RGB color space (default)

If the former switch is ON, it can also be specified an optional color profile parameter, that can be an ICC/ICM file, or a JPG/JPEG (from which a color profile is extracted).

The *color space* parameter can be set equal to:

AUTO
GRAY
RGB
CMYK
YCBCR
YCBCRK
YCCK

Use one of this value if the image is not shown correctly.

COLOR

This directive modifies the colors, brightness, contrast, and saturation of images (and text) being rendered on a range of cards. See directives IMAGE (page 132), ICONS (page 129), PATTERN (page 161) and TEXT (page 180).

Syntax:

COLOR = “range”, html color, *bri-con-sat*

Parameters:

“range”: a set of cards

html color: color used for rendering the image, in the same format used for HTML. If you want to maintain the original colors, you must use a median gray (#808080)

bri-con-sat: a triplet of brightness, contrast, and saturation value, used for rendering the image, written in hexadecimal format (like an html color), starting with an ampersand (&) character. If you want to maintain some of the original values, use the median value (hexadecimal 80). If this parameter is omitted, are used three neutral values (&808080)

Examples:

```
COLOR = 1, #00FF00  
IMAGE = 1, "c:\images\earth.jpg", 0, 0, 6, 9, 0, P  
Result: Figure 17
```

```
COLOR = 1, #808080, &FF8080  
IMAGE = 1, "c:\images\earth.jpg", 0, 0, 6, 9, 0, P  
Result: Figure 18
```



Figure 17



Figure 18

COLORCHANGE

This directive changes one color into another, in a rectangle area of a range of cards.

Syntax:

COLORCHANGE = “range”, pos x, pos y, width, height, html color source, html color destination, *level*, *flags*, “*mask file*”, *schema*, *corner rounding*

Parameters:

“**range**”: a set of cards

pos x: horizontal position (in cm)

pos y: vertical position (in cm)

width: width of the rectangle (in cm)

height: height of the rectangle (in cm)

html color source: a color value, in HTML format

html color destination: a color value, in HTML format

level: if zero, the source color is exactly the one specified in the 6th parameter, otherwise are taken also colors that differ from that source a value equal this parameter in one, two, or three RGB components (with R flag) or HSL components (with L flag); with B flag, is the number of times the blur routine is applied

flags: one or more of the following flags:

S	the replaced color is always the same (default)
V	the replaced color changes, depending from the RGB distance from the original
H	the replaced color changes, depending from the HSL distance from the original
R	the level is calculated using RGB values (default)
L	the level is calculated using HSL values
A	you can specify more than one change, as sequences of sources and destinations
B	instead of changing colors, the selected rectangle is blurred
I	instead of changing colors, the selected rectangle is inverted

“*mask file*”: the transparency layer of this image is used to determine where to apply the color change and the blur effect

schema: this is a matrix of 5x5 numbers, used as factors to change the weight of each pixel, when the average is calculated for the blur, for example 0111001210023200121001110

corner rounding: if specified, it is the radius (in cm) of the rounded corners of the area where the effect is applied

COLORS

This directive writes from one to four colors into as many variables, that can be used instead of a color value.

Syntax:

COLORS = “range”, html color1, *html color2*, *html color3*, *html color4*, *html color5*

Parameters:

“**range**”: a set of cards

html color1: a color value, in HTML format, that is stored into variable #ZZZZZZ

html color2: a color value, in HTML format, that is stored into variable #YYYYYY

html color3: a color value, in HTML format, that is stored into variable #XXXXXX

html color4: a color value, in HTML format, that is stored into variable #WWWWWW

html color5: a color value, in HTML format, that is stored into variable #VVVVVV

Instead of a color, you can use another variable, or the syntax #XçY to read a color located at position X, Y of the current card (you can use also % with each value, for example: #50%ç50%).

With the syntax #X1çY1çX2çY2 you can read the most used color in an image, (the image starts from X1, Y1 and end to X2, Y2).

With the syntax #X1çY1çX2çY2çMinçMax you can read the most used color in an image, (the image starts from X1, Y1 and end to X2, Y2), excluding colors with percent brightness lower than **Min** and higher than **Max**.

With the syntax #AAAAA>#BBBBB<#CCCCCC you can select between two colors: if the brightness of color #A is more or equal to 50%, the variable is set to color #B, if the brightness is less than 50%, the variable is set to color #C. This condition can be modified by using the syntax #AAAAA>#BBBBB<#CCCCCC\$Xnumber, where **number** is a % value, and **X** is a character from this list:

R	Red component
G	Green component
B	Blue component
H	Hue value
S	Saturation value
L	Brightness value

Every color can be also modified adding a value for saturation and a value for brightness change (in percent), with the syntax #000000+saturation+brightness (the values for saturation and brightness can also be negatives).

Example:

```
COLORS = 1, #FF0000
COLORS = 2, #00FF00
COLORS = 3, #0000FF
RECTANGLE = 1-3, 0, 0, 100%, 100%, #ZZZZZZ
```

COMMENT

This directive sets the character used for comments, and eventually activate the in-line comments. The utilization of this directive is equivalent to the settings in the "Config" section of the program.

Syntax:

COMMENT = character, *INLINE*

Parameters:

character: the character used for comments, it must be the first character of the line

INLINE: the same character (doubled) will be used for in-line comments

Examples:

```
COMMENT = &
& This is a comment

COMMENT = !, INLINE
RECTANGLE=1, 0, 0, 6, 9, #00FF00 !! This is another comment
```

COMPARE

This directive compares the cards built with the current script with those built with the filename specified as a parameter and creates a range (to be used with PRINT=COMPARE) with only the cards which are different.

Syntax:

```
COMPARE = "filename"
```

Parameter:

"filename": the filename to be compared with the current script

Example:

```
COMPARE="script_ver1.txt"  
PRINT=COMPARE
```

COPY

This directive does a copy-and-paste of a section of a card into another position on the same card. If you want to copy a section of a card onto another card, you must use the SAVE and IMAGE directives (see page 171).

Syntax:

```
COPY = "range", pos x1, pos y1, width1, height1, pos x2, pos y2, width2, height2, angle, flags
```

Parameters:

"range": a set of cards

pos x1: starting horizontal position (in cm) of the image

pos y1: starting vertical position (in cm) of the image

width1: starting width of the image (in cm)

height1: starting height of the image (in cm)

pos x2: ending horizontal position (in cm) of the image

pos y2: ending vertical position (in cm) of the image

width2: ending width of the image (in cm)

height2: ending height of the image (in cm)

angle: angle of image rotation, can be 0 for no rotation

flags: in this parameter, you can specify a special behavior for the image, possible values are:

H Horizontal mirror
V Vertical mirror

Example:

```
IMAGE = 1, " c:\images\earth.jpg", 0, 0, 3, 3.5, 0, P  
FONT = Arial, 16, , #FFFFFF, #00000  
TEXT = 1, "Earth", 0, 3.5, 3, 1, CENTER, CENTER  
COPY = 1, 0, 0, 3, 4.5, 3, 0, 3, 4.5, 0, H  
COPY = 1, 0, 0, 3, 4.5, 0, 4.5, 3, 4.5, 0, V  
COPY = 1, 0, 0, 3, 4.5, 3, 4.5, 3, 4.5, 0, HV
```

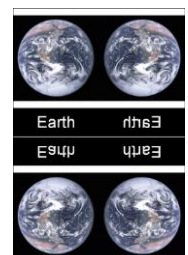

Figure 19

COPYCARD

This directive duplicates cards from a source range to a destination range. Both source and destination ranges can be single cards.

Syntax:

COPYCARD = “destination range”, “source range”, *flags*

Parameters:

“**destination range**”: a set of cards

“**source range**”: a set of cards

flags: one or more of the following flags:

F rotate the cards upside down

Example:

```
COPYCARD = "5-8", "1-2"
```

This is the deck, before the directive:

CARD 1
CARD 2
CARD 3
CARD 4

This is the deck, after the directive:

CARD 1
CARD 2
CARD 3
CARD 4
CARD 1
CARD 2
CARD 1
CARD 2

CORRECTION

This directive enables/disables the pixel correction. If enabled, one pixel is added to width and heights of ELLIPSE, RECTANGLE, ROUNDRECT, and RHOMBUS directives. The correction default is ON.

Syntax:

CORRECTION = “range”, switch

Parameters:

“**range**”: a range of cards

switch: values accepted are:

ON Pixel correction enabled
OFF Pixel correction disabled

Example:

CORRECTION = 1, OFF

COUNTER

This directive sets a counter to a value. A counter is a variable that can be used in expressions (see page 60). This directive can be used with a dice (see DICE directive, page 102) to revert it into a counter. Note: after the build, a warning is issued if one counter is used in an expression without being initialized.

Syntax:

COUNTER = “range”, counter name, counter value, *counter inc*, *counter limit*

Parameters:

“range”: a set of cards

counter name: a counter letter(s)

counter value: a value, it can be a fixed number or an expression

counter inc: each time the counter is used, is incremented of this value (or decremented, if negative)

counter limit: if the value of the counter is higher of this value, the counter is reset at the starting value

Valid counters for integer values:

A B C D E F G H I J

Valid counters for floating values:

AA BB CC DD EE FF GG HH II JJ

Examples:

COUNTER = "1", A, 100

COUNTER = "1-10", B, 2D6

DECK

This directive prepares a deck of cards to be used in the “Virtual table” option (see page 71). If you do not use this directive, the program prepares a deck to be used in the virtual table with all the cards.

Syntax:

DECK = “range”, “deck name”, html color, height, *flag*, *back range*, *pos x*, *pos y*, *starting frames*, *frames*, *rules*, *chromakey*

Parameters:

“range”: a set of cards

“deck name”: the name of the deck

html color: deck color in the same format used for HTML

height: height of the deck (in pixels), you can also specify a % of the screen’s height. The deck’s width is proportional to the height

flag: you can specify these options:

R the deck is shuffled (the default)
N the deck is not shuffled (the order of the cards is that one specified in “range” parameter)
D the deck is placed face down (the default)
U the deck is placed face up
E when the deck is empty it is eliminated

back range: if you specify a number for this parameter, for the deck image (back of cards) is used that card (taken from the deck) instead of a color. You can also use a range of cards for this parameter

pos x: horizontal position for the deck (in pixels), you can also specify a % of the screen’s width

pos y: vertical position for the deck (in pixels), you can also specify a % of the screen’s height

starting frames: if specified, the deck is placed in a frame randomly taken from this list

frames: when a card from this deck is moved on the table, it is positioned in the nearest frame from this list

rules: when a card from this deck is moved on the table, are enforced the rules specified in this list (see page 71 for a list of rules)

chromakey: the color in the card specified in this parameter is treated as transparent, or the transparent color will be taken from one of the four corners or the center of the card, as specified by one of these keywords:

TOPLEFT
TOPRIGHT
BOTTOMLEFT
BOTTOMRIGHT
CENTER
NULL

Note: the DECK directive is not compatible with the DUPLEX directive, do not use both in the same script.

Example:

```
DECK = 1-13, "Hearts", #FF0000, 50%
```

DEPTH

This directive changes the number of bitplanes (and therefore the maximum number of colors) used in storing the cards’ images, so you can use less RAM and can manage more cards.

Syntax:

DEPTH = “range”, bitplanes

Parameters:

“range”: a set of cards

The *bitplanes* parameter can be set equal to:

24	16 million of colors (the default)
16	65536 colors
8	256 colors
4	16 colors

DICE

This directive converts one counter into a dice (it can be used later in expressions).

Syntax:

DICE = “range”, counter, “dice range”, dice number, *flags*, *default1*, *default2*, *reroll*

Parameters:

“**range**”: a set of cards

counter name: valid counters are:

A B C D E F G H I J

“**dice range**”: a range of values, from which is taken the result of the dice roll; if a “>>” is added, the result adds another roll; if a “<<” is added, the result subtracts another roll; if a “***” is added, the result is rerolled

dice number: the number of dice rolled

flags: the syntax for this parameter is *fng*, where *f* is the flag that specify how the dice are grouped, *n* is a number that specify how much dice are used, and *g* is the flag that specify how the dice to be grouped are chosen from the main pool

The 1st flag can be chosen between:

+ sum (the default, if not specified)
* multiply
- subtract
absolute value after subtracting
£ concatenate
^ concatenate without duplicates

The 2nd flag can be chosen between:

+ upper dice (the default, if not specified)
- lower dice

default1: the value to be used if the number before the dice is missing

default2: the value to be used if the number after the dice is missing

reroll: the times the dice are rerolled if the result is marked with “***”

Example, rolling four dice (with values from one to six) and sum the upper three:

DICE = 1, A, "1-6", 4, +3+

Example, rolling four open dice (subtracting dice for one, adding dice for six):

DICE = 1, A, "1<<,2,3,4,5,6>>", 4

Example, rolling four dice, and rerolling them three times when the result is “-1”:

DICE = 1, A, "-1**, -1**, 0, 0, 1, 1", 4, , , , 3

DISPLAY

This directive draws a list of cards to the canvas (card 0), resizing it accordingly, and save it with a filename (if specified). If the range is omitted, all the deck is drawn and saved. The width parameter is the number of cards in horizontal, if omitted, is chosen the maximum number from the factors of the total number of the cards. Note that if there are N cards, and N is a prime number, the default result will be a line of N cards (since the only other number that is a divisor of a prime number is one); in this case you can specify a different width, and the last cards would be filled with blanks. Instead of specifying starting and ending card, you can use a range as 5th parameter (leave the other at zero).

If you specify a filename with a question mark (?) as a first character, the program asks you if the existing file must be overwritten. If you specify the keywords (R90), (R180), or (R270) at the start of the filename, the resulting image is rotated accordingly.

Syntax:

DISPLAY = "*image file*", *first card*, *last card*, *width*, "*range*", *transparent color*, "*mask file*", *bitplanes*, *pos x*, *pos y*, *width*, *height*

Parameters:

"*image file*": the name of the saved file

first card: the first card drawn in the file

last card: the last card drawn in the file

width: the width (in cards) of the rectangle, you can also specify a height with the syntax *width*x*height*, in this case multiple files can be created (replacing a \$ symbol with a counter, and the # symbol with the number of cards in current image file)

"*range*": the set of cards drawn in the file

transparent color: for PNG and GIF, if this parameter is specified, the file is saved with this color as transparent, for PNG files you can also specify more than one color (for example #0000FF#00FF00 for two colors) and add a level of transparency, in the format #*xyyyyyyy*, where *xx* = transparency level (from 00 = full transparent to FF = full solid) and *yyyyyy* = color. Another format accepted is #*xyyyyyyyzzz*, where *zzz* is a number that is used as "likeness" of the color to be treated as transparent. Finally, you can also specify a G at the end to proportionally adjust the level of transparency to the level of likeness.

"*mask file*": if this parameter is specified (a PNG image), is used as transparency mask for the saved image (note that in this case the "transparent color" is not used)

bitplanes: sets the depth of the saved image, and can be set equal to:

24	16 million of colors (the default)
16	65536 colors
8	256 colors
4	16 colors

pos x: horizontal position of the saved area (in cm)

pos y: vertical position of the saved area (in cm)

width: width of the saved area (in cm)

height: height of the saved area (in cm)

Example:

```
DISPLAY = "c:\deck.png", 1, 10
```

DOWNLOAD

This directive downloads a file from Internet if the file does not already exist in the specified path.

Syntax:

DOWNLOAD = URL, "*filename*"

Parameters:

URL: the URL for a file, it must start with **http://** or **https://**

"*filename*": the path and filename for the downloaded file, if omitted, the path is the current folder, and the name is taken from the URL parameter.

Example:

DOWNLOAD = <http://game-icons.net/icons/delapouite/originals/png/sheep.png>

You can also use two sequences, one for the URLs and one for the filenames.

DPI

This directive sets the resolution of cards (in Dots Per Inch). If omitted, is 300 (the default for printing); if you want to show the cards on screen, you can use a value of 150.

Syntax:

DPI = dpi number

Note that with a value too high, the time of rendering can be exceptionally long, and the program uses more memory (or disk space).

Example:

DPI = 150

DRAW

This directive draws several cards from a deck in the “Virtual table” option (see page 71). If you do not use this directive, the program prepares a deck to be used in the virtual table with all the cards. If you specify a new name, a deck is created with the card drawn, if you leave the 2nd parameter empty, the cards drawn are shown into the table as separated objects.

Syntax:

DRAW = “deck name”, “deck name new”, number, *flag*, *pos x*, *pos y*, *starting frames*

Parameters:

“**deck name**”: the name of the deck from which the cards are drawn

“**deck name new**”: the name of the deck created with the cards drawn

number: the number of cards drawn

flag: you can specify these options:

R	the deck is shuffled (the default)
N	the deck is not shuffled (the order of the cards is that one specified in "range" parameter)
D	the deck is placed face down (the default)
U	the deck is placed face up

pos x: horizontal position for the cards/deck drawn (in pixels), you can also specify a % of the screen’s width

pos y: vertical position for the cards/deck drawn (in pixels), you can also specify a % of the screen’s height

starting frames: if specified, the cards drawn are placed in frames randomly taken from this list

Example:

DRAW = "standard", "new", 10, U

DUPLEX

This directive copies a card (or a range of cards) to another position (or range) calculated automatically by the software, it is useful to manage duplicates or synchronize the front and back of cards for a duplex printing. You can also specify multiple ranges in 1st and 2nd parameter as sequences of ranges. See also PRINT directive (see page 166).

Syntax:

DUPLEX = “range front”, “range back”, *number*

Parameters:

“**range front**”: a card or a range of card to be copied

“**range back**”: a card or a range of card to be copied, front-to-back with the card(s) specified in the 1st parameter

number: if specified, the card is replicated several times; if not specified, it is treated like one copy

Example:

```
DUPLEX = 1-10, 11
DUPLEX = 12-21, 22, 2
DUPLEX = 1-3|4-6, 7|8
```

Note: since nanDECK need to add cards to the deck, you must not use a CARDS directive in the script.

Note: the DUPLEX directive is not compatible with the DECK directive, do not use both in the same script.

EDGE

This directive changes the style used for drawing the lines / boundaries with these directives:

```
BEZIER
BEZIERS
CIRCLE
ELLIPSE
HEXGRID
LINE
LINERECT
GRID
PIE
POLYGON
RECTANGLE
RHOMBUS
ROUNRECT
STAR
TRACK
TRACKRECT
TRIANGLE
```

Syntax:

EDGE = “range”, type, *pattern*, *tip*, *join*

Parameters:

“**range**”: a set of cards

type: you can choose a type between these options:

SOLID draws a solid line (the default)

INSIDE	the same as solid, but inside the rectangle
DASH	draws a dashed line
DOT	draws a dotted line
DASHDOT	draws a line alternating a dash and a dot
DASHDOTDOT	draws a line alternating a dash and two dots
NULL	does not draw a border
CUSTOM	draws a line using a custom pattern

pattern: a pattern for the custom style, this pattern can be composed of:

O	dot
D	dash
S	space

These letters can be repeated, for example “OSDSOS” is a valid pattern.

tip: you can choose a pen tip between these options:

ROUND	the pen tip is a circle (the default)
SQUARE	the pen tip is a square
FLAT	the pen tip is a line

join: you can choose the method to join the lines between these options:

ROUND	the angles are rounded (the default)
BEVEL	the angles are blunted
MITER	the angles are squared

ELLIPSE

This directive draws an ellipse in a set of cards.

Syntax:

ELLIPSE = “range”, pos x, pos y, width, height, html color, *html color*, *thickness*

Parameters:

“**range**”: a set of cards

pos x: horizontal position (in cm)

pos y: vertical position (in cm)

width: width of the ellipse (in cm)

height: height of the ellipse (in cm)

html color: border color of the ellipse, in the same format used for HTML, you can also specify a gradient

html color: inner color of the ellipse, in the same format used for HTML, if not specified the inner color is the same of border color. You can also specify “EMPTY” for a hollow ellipse or a gradient

thickness: thickness of the border of the ellipse (in cm), if omitted, the ellipse’s border is 1 pixel wide

Examples:

```
ELLIPSE = 1, 1, 1, 4, 7, #00FF00
```

Result: Figure 20

```
ELLIPSE = 1, 1, 1, 4, 7, #FF00FF, EMPTY, 0.1
```

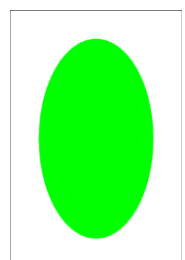

Figure 20

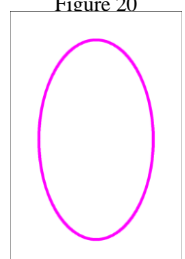

Figure 21

Result: Figure 21

```
ELLIPSE = 1, 1, 1, 4, 7, #FF0000#0000FF@90
```

Result: Figure 22

ELSE

This directive is used in a structure IF...ENDIF to specify a code that must be executed only if the test in the IF directive is not true (see page 131).

Syntax:

```
ELSE
```

Parameters:

none

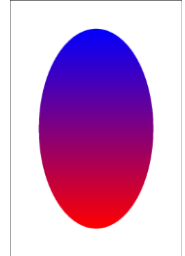

Figure 22

ELSEIF

This directive is used in a structure IF...ENDIF to specify a code that must be executed only if the test in this line is true and the test in the first IF directive is false (see page 131).

Syntax:

```
...  
ELSEIF = value1 operator value2  
...
```

Parameters:

value: a string, number, label, or expression that can be evaluated

operator: the condition is evaluated using the two values and this operator, you can use one operator from the same listed for the IF directive

END

This directive is used to close a MACRO...END structure (see page 154).

Syntax:

```
END
```

Parameters:

none

ENDFRAME

This directive closes a FRAME...ENDFRAME structure (see page 117).

Syntax:

```
ENDFRAME
```

Parameters:

none

ENDIF

This directive is used to close an IF...ENDIF structure (see page 131).

Syntax:

ENDIF

Parameters:

none

ENDIMAGEENC

This directive closes an IMAGEENC...ENDIMAGEENC structure (see page 135).

Syntax:

ENDLAYER

Parameters:

none

ENDLAYER

This directive closes a LAYER...ENDLAYER structure (see page 140).

Syntax:

ENDLAYER

Parameters:

none

ENDLINK

This directive closes a LINK...ENDLINK structure (see page 144).

Syntax:

ENDLINK

Parameters:

none

Example:

```
linkmulti=num
link=
num,string
1,alpha
2,beta
3,gamma
endlink
[all]="1- { (num) }"
font=Arial,48,, #000000
text=[all],[num],0,0,100%,50%
text=[all],[string],0,50%,100%,50%
```

ENDSECTION

This directive closes a SECTION...ENDSECTION structure (see page 174).

Syntax:

ENDSECTION

Parameters:

none

ENDSELECT

This directive is used to close a SELECT...ENDSELECT structure (see page 174).

Syntax:

ENDSELECT

Parameters:

none

ENDSEQUENCE

This directive is used to close a SEQUENCE...ENDSEQUENCE structure (see page 175).

Syntax:

ENDSEQUENCE

Parameters:

none

ENDVISUAL

This directive closes a VISUAL...ENDVISUAL structure (see page 189).

Syntax:

ENDVISUAL

Parameters:

none

EXPRESSION

This directive specifies the characters used to define expressions to be evaluated in texts in HTMLTEXT (see page 127) and RTFTEXT (see page 170) directives.

Syntax:

EXPRESSION = exp. HTML start, exp. HTML end, exp. RTF start, exp. RTF end

Parameters:

exp. HTML start: character(s) used to define start of expressions in HTMLTEXT directive

exp. HTML end: character(s) used to define end of expressions in HTMLTEXT directive

exp. RTF start: character(s) used to define start of expressions in RTFTEXT directive

exp. RTF end: character(s) used to define end of expressions in RTFTEXT directive

Example:

```
EXPRESSION = { , }
```

FACTORS

This directive sets two factors used in elements printed with HTMLTEXT (see page 127).

Syntax:

```
FACTORS = background size factor, font size factor
```

Parameters:

background size factor: the size of the background printed with B flag is multiplied for this value

font size factor: the size of the font is multiplied for this value

Example:

```
FACTORS = 1.2
```

FILL

This directive fills a region with a color (the region is delimited by another color).

Syntax:

```
FILL = "range", pos x, pos y, html fill color, html border color, flags
```

Parameters:

"range": a set of cards

pos x: horizontal initial position (in cm) of the fill

pos y: vertical initial position (in cm) of the fill

html fill color: color of the fill. You can also specify a gradient

html border color: this is the area color (or boundary color) for the fill

flags: one of the following flags

A the 5th parameter is the color of the area to be filled

B the 5th parameter is the color of the boundary that enclose the area to be filled

If you do not specify a flag, it is considered B as default.

Example:

```
LINE = 1, 0, 1, 6, 1, #0000FF, 0.1  
LINE = 1, 0, 8, 6, 8, #0000FF, 0.1  
LINE = 1, 1, 0, 1, 9, #0000FF, 0.1  
LINE = 1, 5, 0, 5, 9, #0000FF, 0.1  
LINE = 1, 0, 9, 6, 0, #0000FF, 0.1  
FILL = 1, 2, 2, #FFFF00#FF8000@0, #0000FF
```

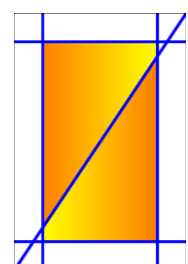

Figure 23

```
FILL = 1, 2, 7, #FF8000#FFFF00@0, #0000FF
```

Result: Figure 23

FLAGS

This directive sets a set of flags to all the subsequent directives in the script. If you want to remove a flag instead of adding it, use before the “-” symbol (minus).

Syntax:

```
FLAGS = “range”, directive, flags
```

Parameters:

“**range**”: a set of cards

directive: the directive affected by the flags

flags: the flag or flags to be set

Example:

```
FLAGS = 1-10, HTMLTEXT, BE
```

FOLD

This directive copies a card (or a range of cards) to another position (or range) calculated automatically by the software, it is useful when you want to print fronts and backs of cards on a single page, that can be folded on the horizontal or vertical axis and glued (note that with the horizontal folding the backs are rotated 180°). You can also specify multiple ranges in 1st and 2nd parameter as sequences of ranges. See also PRINT directive (see page 166).

Syntax:

```
FOLD = “range front”, “range back”, number, flags
```

Parameters:

“**range front**”: a card or a range of card to be copied

“**range back**”: a card or a range of card to be copied, front-to-back with the card(s) specified in the 1st parameter,

number: if specified, the card is replicated several times; if not specified, it is treated like one copy

flags: one or more of the following flags

H	the folding line is horizontal (if not specified, this is the default folding for landscape page orientation)
V	the folding line is vertical (if not specified, this is the default folding for portrait page orientation)
A	if there is a horizontal folding line, the vertical gap is augmented until there is an even number of rows, if there is a vertical folding line, the horizontal gap is augmented until there is an even number of columns

Example:

```
FOLD = 1-10, 11  
FOLD = 12-21, 22, 2  
DUPLEX = 1-3|4-6, 7|8
```

Note: since nanDECK need to add cards to the deck, you must not use a CARDS directive in the script.

Note: the FOLD directive is not compatible with the DECK directive, do not use both in the same script.

FOLDER

This directive sets the current working directory (if you do not specify it, it will be used the folder where the script is located).

Syntax:

FOLDER = "folder"

Parameters:

"folder": the folder to be used as current working directory

Example:

```
FOLDER = "c:\projects\test"
```

FONT

This directive sets the font for any following TEXT command (see page 180). Note that there is not any reference to a range of cards. If you want a ranged command, you can use FONTRANGE instead (see page 115).

Syntax:

FONT = "font name", font size, style, html color font, *html color background*, *outline x*, *outline y*, *step x*, *step y*, *char space*

Parameters:

"font name": character font name (string)

font size: character font size, in typographical points (1 point = 1/72 of an inch)

style: character font style and flag used for visualization; values accepted are:

B	bold
I	italic
U	underline
S	strikeout
T	transparent font background
N	do not clip text at the boundary
C	circular text
R	circular text, reversed
H	circular text, half circumference
Q	circular text, one quarter circumference
E	circular text, three quarter circumference
Z	the text follows the curve drawn with the last BEZIER directive
F	the size is reduced until the text fits in the rectangle specified by TEXT directive (this value is stored in TF var)
V	vertical text
P	do not clip text area beyond the rectangle
O	transparent font text (flag T is ignored)
D	the text is placed in the rectangle's diagonal (from top-left to bottom-right)
G	the text is placed in the rectangle's diagonal (from top-right to bottom-left)
A	gradient is calculated from the text instead of from the rectangle
X	the text is shrunk if too large to fit the rectangle
Y	the text is stretched if too small to fit the rectangle

html color font: character color, in the same format used for HTML, you can also specify a gradient

html color background: background color, in the same format used for HTML, you can also specify a gradient

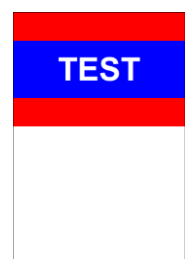

Figure 24

This parameter can be omitted (it will be used the last background color used, or white if none was specified), if you specified T as a style flag, the background color will not be used

Tip: you can choose the font with a Windows standard dialog, clicking on the button "Insert" and choosing the menu voice "Font".

Examples (the difference was in the T flag in the 2nd FONT command):

```
RECTANGLE = 1, 0, 0, 6, 4, #FF0000
FONT = "Arial", 32, B, #FFFFFF, #0000FF
TEXT = 1, "TEST", 0, 1, 6, 2, center
```

Result: Figure 24

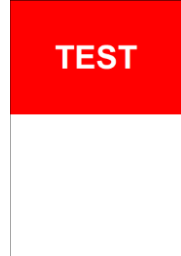

```
RECTANGLE = 1, 0, 0, 6, 4, #FF0000
FONT = "Arial", 32, BT, #FFFFFF, #0000FF
TEXT = 1, "TEST", 0, 1, 6, 2, center
```

Result: Figure 25

Figure 25

outline x: horizontal expansion in cm, with that parameter the text will be replicated horizontally from -x to +x

outline y: vertical expansion in cm, with that parameter the text will be replicated vertically from -y to +y

step x: the number of times the text is printed horizontally

step y: the number of times the text is printed vertically

char space: spacing added (or removed, if negative) between characters in circular text (if not present, the text is justified)

Example:

```
FONT = "Arial", 32, B, #FFFFFF, #0000FF, 0.1, 0.1
TEXT = 1, "TEST", 0, 1, 6, 2, center
```

Result: Figure 26



Figure 26

FONTALIAS

This directive enables/disables the font anti-aliasing, using the Operating System's routines. It is useful to remove colored pixels in the text's boundaries, especially when using HTMLTEXT (see page 127) or RTFTEXT (see page 170) directives with transparent background.

Syntax:

FONTALIAS = "range", switch

Parameters:

"range": a range of cards

switch: values accepted are:

- ON Font anti-aliasing enabled
- OFF Font anti-aliasing disabled

Example:

```
{[html_on]="<style type='text/css'>p {font-size: 32px}</style><p>
ANTIALIASING ON</p>"}
{[html_off]="<style type='text/css'>p {font-size: 32px}</style><p>
ANTIALIASING OFF</p>"}
ELLIPSE = 1, 0, 0, 6, 3, #FF0000
```

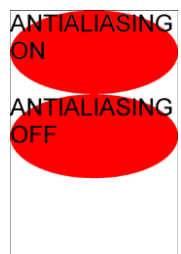

Figure 27

```

ELLIPSE = 1, 0, 3, 6, 3, #FF0000
FONTALIAS = 1, ON
HTMLTEXT = 1, [html_on], 0, 0, 6, 3, #FFFFFF, 0, T
FONTALIAS = 1, OFF
HTMLTEXT = 1, [html_off], 0, 3, 6, 3, #FFFFFF, 0, T

```

Result: Figure 27

FONTCHANGE

This directive changes a font in the script with another. It is useful when you want to test a script on a computer that does not have a font, and you did not want to change all the occurrences (or use a label).

Syntax:

```
FONTCHANGE = "old font", "new font"
```

Parameters:

“old font”: the font that you want to be changed

“new font”: the font that you want to use instead

Example:

```
FONTCHANGE = "Calibri", "Times New Roman"
```

FONTRANGE

This command is equivalent to FONT (see page 113) but is applied to a range of cards (specified by the 1st parameter).

Syntax:

```
FONTRANGE = "range", "font name", font size, style, html color font, html color background, outline x, outline y, step x, step y, char space
```

Parameters:

“range”: a range of cards

“font name”: character font name (string)

size: character font size, in typographical points (1 point = 1/72 of an inch)

style: character font style and flag used for visualization; values accepted are:

B	bold
I	italic
U	underline
S	strikeout
T	transparent font background
N	do not clip text at the boundary
C	circular text
R	circular text, reversed
H	circular text, half circumference
Q	circular text, one quarter circumference
E	circular text, three quarter circumference
Z	the text follows the curve drawn with the last BEZIER directive
F	the size is reduced until the text fits in the rectangle specified by TEXT directive
V	vertical text
P	do not clip text area beyond the rectangle
O	transparent font text (flag T is ignored)
D	the text is placed in the rectangle's diagonal (from top-left to bottom-right)

G the text is placed in the rectangle's diagonal (from top-right to bottom-left)
 A gradient is calculated from the text instead of from the rectangle
 X the text is shrunk if too large to fit the rectangle
 Y the text is stretched if too small to fit the rectangle

html color font: character color, in the same format used for HTML, you can also specify a gradient

html color background: background color, in the same format used for HTML, you can also specify a gradient

outline x: horizontal expansion in cm, with that parameter the text will be replicated horizontally from $-x$ to $+x$

outline y: vertical expansion in cm, with that parameter the text will be replicated vertically from $-y$ to $+y$

step x: the number of times the text is printed horizontally

step y: the number of times the text is printed vertically

char space: spacing between characters in circular text (if not present, the text is justified)

Tip: you can choose the font with a Windows standard dialog, clicking on the button "Insert" and choosing the menu voice "Font".

FOOTER

This directive prints a text in the page's footer specified by a page range (with a syntax like cards' range).

Syntax:

FOOTER = "page range", "text", *horizontal alignment*

Parameters:

"page range": a set of pages, if empty the text is printed onto all the pages

"text": the text to be printed, you can also use four variables:

{P} page number
 {N} total page number
 {D} date
 {T} time

horizontal alignment: the text's horizontal alignment in the page, values accepted are:

LEFT left aligned
 CENTER centered
 RIGHT right aligned

If not specified, the text is centered.

Examples:

FOOTER = "1-3", "Deck 1", CENTER

FOOTER = "", "printed {D} {T}", RIGHT

FOR

This directive executes the code between a FOR row and a NEXT row (see page 158), exiting when the **counter** value is equal to **end** value, starting from **start** value and adding a **step** value at each loop.

Syntax:

FOR = counter name, start, end, *step*

Parameters:

counter name: the variable counter storing the value, can be chosen between A B C E F G H I J

start: starting value for the counter

end: ending value for the counter

step: increment for counter at each loop, if not specified is assumed to be 1

Example:

```
FOR = A, 1, 4
  FOR = B, 1, 7
    RECTANGLE = 1, A, B, 1, 1, #FF0000, #0000FF
  NEXT
NEXT
```

Result: Figure 28

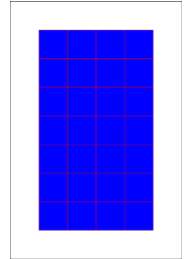

Figure 28

FRAME

This directive is used in a FRAME...ENDFRAME structure to define frames using characters in rectangular patterns, for example, if you want to define three frames, one for the card, one for an image and one for the text below, you can write these lines:

```
FRAME
AAAAAA
ABBBBA
ABBBBA
ABBBBA
ACCCCA
ACCCCA
AAAAAA
ENDFRAME
```

The result is equal to these lines:

```
<A>=0%, 0%, 100%, 100%
<B>=16.7%, 14.3%, 66.7%, 42.9%
<C>=16.7%, 57.1%, 66.7%, 28.6%
```

With this method, you can create 36 frames (one for each letter/number), the names are case-insensitive.

Syntax:

FRAME = *list split frames*

Parameters:

list split frames: if you add here some frames, these frames are treated individually, and are not merged in a single frame. In the last example, if you specify **B** as a parameter, instead of one frame, the program creates twelve frames (all named **B**)

GAP

This directive sets a space between cards in printed pages. If the directive GAP is not specified, there will be no gap between cards.

Syntax:

GAP = horizontal gap, vertical gap, *line switch*, *fill switch*, *guidelines*, *guide color*, *cross size*

Parameters:

horizontal gap: horizontal space (in cm)

vertical gap: vertical spaces (in cm)

line switch: values accepted are:

ON to enable a guideline in the middle of the gap
OFF to disable it (the default)

fill switch: values accepted are:

ON when using CROSS guidelines, they are prolonged across the middle of the gap
OFF the middle of the gap is not drawn (the default)

guidelines: the graphic type of the middle guideline (if present). You can choose between:

NONE	no guideline
SOLID	solid lines
DOTTED	dotted lines
DASHED	dashed lines
MARK	draws cut marks only (solid lines)
MARKDOT	draws cut marks only (dotted lines)
MARKDASH	draws cut marks only (dashed lines)
CROSS	draws cut marks and crosses (solid lines, the length is set with the 6th parameter)
CROSSDOT	draws cut marks and crosses (dotted lines, the length is set with the 6th parameter)
CROSSDASH	draws cut marks and crosses (dashed lines, the length is set with the 6th parameter)

guide color: color of the middle guideline (if present), in the same format used for HTML, same color of other guidelines if not specified

cross size: length of the arm of the cross (in cm) for CROSS/CROSSDOT/CROSSDASH guideline type

If the directive GAP is not specified, there is no gap between cards.

Example:

GAP = 1, 1

GRADIENTS

This directive can be used to specify additional parameters used in drawing gradients, or to add other gradients color; it works on every directive that uses gradients, and you can use more than one GRADIENTS directive.

Syntax:

GRADIENTS = "range", compression, *rotation*, *flags*, *pos x*, *pos y*, *html color*, *factor*, *twist*, *scatter*

Parameters:

“range”: a set of cards

compression: a factor used to draw gradient bands narrowly (greater than 1) or broadly (less than 1)

rotation: each axis is rotated of this angle (in degrees), it is used also in conic or star gradients

flags: you can use the following flags:

- N each pixel is drawn in the color of the closest axis between the two that define the sector in which it resides
- F each pixel is drawn in the color of the farthest axis between the two that define the sector in which it resides
- M each pixel is drawn in the average color of the two axis that defines the sector in which it resides
- A each pixel is drawn in the average color of all axes
- P each pixel is drawn in the average color of all axes, proportionally to the distance from the point specified with 5th and 6th parameters; it is also used in all the special gradients to specify the origin point
- D delete all current gradients

pos x: horizontal position (in cm) of point used with P flag

pos y: vertical position (in cm) of point used with P flag

html color: in the same format used for HTML, you can also specify a gradient

factor: for star gradients, it defines the “pointy” aspect of the star

twist: for star gradients, it defines if the star is twisted clockwise (positive number) or counterclockwise (negative number)

scatter: for star gradients, it defines an angle of random scattering

GRID

This directive draws a grid in a set of cards.

Syntax:

GRID = "range", pos x, pos y, width, height, html color, thickness, horiz. cells, vert. cells, *pattern*

Parameters:

“**range**”: a set of cards

pos x: horizontal position (in cm)

pos y: vertical position (in cm)

width: width of the rectangle (in cm)

height: height of the rectangle (in cm)

html color: border color of the grid, in the same format used for HTML, you can also specify a gradient

thickness: thickness of the grid (in cm), if set to zero, the grid’s border will be 1 pixel wide

horiz. cells: number of horizontal cells

vert. cells: number of vertical cells

pattern: a pattern for the line used to draw the grid, this pattern can be composed of:

- O dot
- D dash
- S space

These letters can be repeated, for example “OSDSOS” is a valid pattern.

Example:

GRID = 1, 1, 1, 4, 4, #FF0000#0000FF@90, 0.1, 3, 3

Result: Figure 29

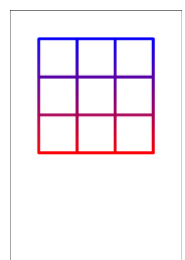

Figure 29

HEADER

This directive prints a text in the page's header specified by a page range (with a syntax like cards' range).

Syntax:

HEADER = "page range", "text", *horizontal alignment*

Parameters:

"page range": a set of pages, if empty the text is printed onto all the pages

"text": the text to be printed, you can also use four variables:

{P} page number
{N} total page number
{D} date
{T} time

horizontal alignment: the text's horizontal alignment in the page, values accepted are:

LEFT left aligned
CENTER centered
RIGHT right aligned

If not specified, the text is centered.

Examples:

```
HEADER = "1-3", "Deck 1", CENTER
```

```
HEADER = "", "printed {D} {T}", RIGHT
```

HEXGRID

This directive draws a hexagonal grid in a set of cards.

Syntax:

HEXGRID = "range", pos x, pos y, width, height, hex side, flags, html color, *html color*, *thickness*

Parameters:

"range": a set of cards

pos x: horizontal position (in cm)

pos y: vertical position (in cm)

width: width of the rectangle (in cm)

height: height of the rectangle (in cm)

hex side: length of the hexagon's side (in cm)

flags: you can use the following flags:

D add a dot in the center of the hexagon
L add a letter in each hexagon (A, B, C...)
N add a number in each hexagon (1, 2, 3...)
P add a zero-padded number in each hexagon (01, 02, 03...)
E add a letter and a number in each hexagon (A1, A2, A3...B1, B2, B3...)

- C add two numbers in each hexagon (11, 12, 13...21, 22, 23...)
- 2 add interlaced coordinates in each hexagon (1.2, 1.4, 1.6...2.3, 2.5, 2.7...)
- .
-
- _
- X do not draw the grid (useful if you want only a dot or a label)

html color: border color of the grid, in the same format used for HTML, you can also specify a gradient

html color: inner color of the hexagons, in the same format used for HTML, if not specified the inner color is the same of border color. You can also specify "EMPTY" for a hollow (and transparent) hexagon or a gradient

thickness: thickness of the grid (in cm), if omitted, the grid's border is 1 pixel wide

Example:

```
FONT = ARIAL, 10, , #000000
HEXGRID = 1, 0, 0, 6, 9, 1, N, #000000, #00FF00
```

Result: Figure 30



Figure 30

HTMLBORDER

This directive draws a border around a text with a specific tag (that was created with HTMLFONT directive, see page 123) to be used in HTMLTEXT directive (see page 127); this directive works only with E flag in HTMLTEXT (MS Explorer).

Syntax:

HTMLBORDER = "html tag", type, html color, thickness, *gap top*, *gap left*, *gap right*, *gap bottom*, *corner rounding*, *html color background*, *alpha*, *min. height*, *max. height*

Parameters:

"html tag": a name used for referencing the font

type: the style used to draw the border, can be one of this keywords:

- RECTANGLE
- DOTTED
- DASHED
- DOUBLE
- GROOVE
- RIDGE
- INSET
- OUTSET
- NONE

html color: the color of the border, in the same format used for HTML

thickness: thickness of the border (in cm)

gap top: the gap between top border and the text, in cm

gap left: the gap between left border and the text, in cm

gap right: the gap between right border and the text, in cm

gap bottom: the gap between bottom border and the text, in cm

corner rounding: the corners of the border are rounded; the value is the radius of the circle used

html color background: the color of the inner rectangle, in the same format used for HTML

alpha: level of transparency of inner rectangle, from 0 (full transparent) to 100 (full solid). If omitted, the level is set to 100 (full solid)

min. height: the minimum height of the inner rectangle, used if the text is smaller than that

max. height: the maximum height of the inner rectangle, used if the text is longer than that

Note: for **type**, **html color**, **thickness**, and **corner rounding** you can specify a sequence of two, three, or four values, that are used for drawing different edges (type, html color, and thickness) or corners (corner rounding).

Example:

```
HTMLFONT = alpha, Arial, 32, , #000000
HTMLBORDER = alpha, DOTTED, #FF0000, 0.1
HTMLTEXT = 1, "this is a test", 0, 0, 100%, 100%, #FFFFFF, 0, EB, 100, alpha
```

HTMLFILE

This directive prints the HTML text loaded from a filename in the cards specified by a range.

Syntax:

HTMLFILE = "range", "html file", pos x, pos y, width, height, *html color*, *angle*, *flags*, *alpha*

Parameters:

"range": a set of cards

"html file": the HTML filename for text to be printed (eventually with a pathname)

pos x: horizontal position (in cm)

pos y: vertical position (in cm)

width: width of the text's rectangle (in cm)

height: height of the text's rectangle (in cm)

html color: background color for text

angle: angle of text rotation, you must specify 0 for no rotation

flags: you can specify one or more flags, chosen between:

T	Transparent background for text
H	Horizontal mirror
V	Vertical mirror
I	HTML rendering with internal engine
A	HTML rendering with internal engine (new)
E	HTML rendering with Explorer
2	Render a x2 image (do not use if you already have an OVERSAMPLE directive)
4	Render a x4 image (do not use if you already have an OVERSAMPLE directive)
8	Render a x8 image (do not use if you already have an OVERSAMPLE directive)
R	Vertical text
B	Transparent background, better rendering of png, works only with E flag (MS Explorer)
W	Wait 100 msec
O	Replace tags also between < and >
C	Clear page after rendering (MS Explorer)
N	Use always a new instance (MS Explorer)



alpha: level of transparency of text, from 0 (full transparent) to 100 (full solid). If omitted, the level is set to 100 (full solid). You can also specify an angle for the transparency, with the format **level@angle**; in this case, the level of transparency is the starting level, ending with 0 (full transparent)

Example:

```
HTMLFILE = 1, "c:\test.html", 0, 0, 6, 9, #FFFFFF, 0, T
```

Result: Figure 31

HTMLFONT

This directive creates a tag that can be used for recalling a font in an HTMLTEXT directive (see page 127), for example, if the tag is **name**, the string “one <name>two</name> three” has the word “two” written with the font defined by it; tags can be nested, therefore if you want the other words to be written with **other** font, you can use the string “<other>one <name>two</name> three</other>”. If you create a tag with name **example**, in HTMLTEXT you can also assign these characteristics in an HTML text using **example** as the 11th parameter. If an alignment is specified, the program creates a “paragraph” font (a <div> tag in HTML) therefore its text is organized in a new paragraph (with a newline added when it’s closed), otherwise the program creates a “text” font (a tag in HTML). In other words, if you want to use different font on the same line, it is possible only by omitting the alignment parameter. Note that for default the text in HTMLTEXT is word-wrapped, so there is not a flag to enable it. There are three special tags: **th**, **tr**, and **td**, that are used with the HTML tags of the same names (i.e., in tables).

Syntax:

HTMLFONT = tag, “font name”, font size, style, html color, *alignment*, *shadow x*, *shadow y*, *shadow blur*, *shadow color*, *outline color*, *outline width*, *indent*, *highlight color*, *char. spacing*, *angle*, *CSS*

Parameters:

tag: a name used for referencing the font

“font name”: character font name (string)

font size: character font size, in typographical points (1 point = 1/72 of an inch)

style: character font style and flag used for visualization; values accepted are:

B	bold
I	italic
U	underline
S	strikeout
O	shadow over outline (the default is outline over shadow)
N	do not resize this font when using F flag in HTMLTEXT (see page 127)
P	resize this font proportionally to the main font when using F flag in HTMLTEXT (see page 127)
R	the outline of the font is done in a more refined way
C	break lines at every character
T	the HTML syntax is formatted for table cells
A	small cap
M	multiple shadows (use sequences for parameters from 7 th to 10 th)
D	keep decimals in the font size calculation
L	round down to integers the font size calculation
G	last line aligned to the right
E	last line aligned to the center
J	last line justified
H	automatic hyphenation (you must specify the language with an HTMLLANG directive, see page 126)
Y	manual hyphenation (you must specify the syllables of a word using one or more &shy ; tag)
Z	forces the text on a single line
W	the text is converted to upper case
V	the text is converted to lower case
F	the first letter of the text is converted to upper case, the others to lower
X	to add the HTML tag for overflow: auto
l	to add the HTML tags for a line of an unordered list

2 to add the HTML tags for a line of an ordered list

html color: character color, in the same format used for HTML

alignment: the text's horizontal alignment, values accepted are:

left left aligned
center centered
right right aligned
justify the text is justified

The horizontal alignment is optional, if omitted is equal to **left**

shadow x: the horizontal offset for a shadow drawn under the text. Note: all the shadow's parameters work only with flag E, and Internet Explorer must be version 11 or more

shadow y: the vertical offset for a shadow drawn under the text

shadow blur: if you specify this parameter, the shadow is blurred

shadow color: the color for the text' shadow, in the same format used for HTML

outline color: the color for the text's outline, in the same format used for HTML

outline width: the width for the text's outline

indent: the indentation in cm of the first line (you can specify a negative number for hanging indentation)

highlight color: color for the background of the text, in the same format used for HTML

char. spacing: the spacing used between each character, it can be negative

angle: the angle of the rotation for the characters

CSS: this text is added to the image definition as a CSS HTML style

Example:

```
HTMLFONT = alpha, Arial, 32, , #000000
HTMLFONT = beta, "Times New Roman", 18, I, #0000FF
HTMLKEY = 1, (test), test, alpha
HTMLTEXT = 1, "This is a (test)", 0, 0, 100%, 100%, #FFFFFF, 0, E, 100, beta
```

Result: Figure 32



Figure 32

HTMLFONTSTEP

The F flag in the HTMLTEXT directive (see page 127) works by reducing the size of the font by steps of one until the text fits in the rectangle area. This directive changes the value of the step. Note that you should not choose a value too small, because if nanDECK does not see a variation in the size of the text (i.e., the variation is small than one pixel), it stops this process.

Syntax:

HTMLFONTSTEP = "range", font size step, *width min*, *adjust multi*

"range": a set of cards

font size step: the value of the step

width min: the minimum threshold for considering when lines have the same length (for G flag in HTMLTEXT), the default is zero

adjust multi: the starting decrement in font size (for F flag in HTMLTEXT), the default is 8

HTMLIMAGE

To simplify insertion of images in HTMLTEXT directives (see page 127), you can specify a name with this directive, associated with a filename, width, and height. When an HTMLTEXT is rendered, the name is substituted with an HTML tag for the image, with the correct size.

Note: in the name do not use [] (they are used for labels) or { } (they are used for calculations).

Syntax:

HTMLIMAGE = “range”, key, “image file”, width, height, *flags*, *angle*, *margin top*, *margin left*, *margin right*, *margin bottom*, *htmlfont*, *pos X*, *pos Y*, CSS

“**range**”: a set of cards

key: the name associated to the image (replaced in HTML)

“**image file**”: the filename for the image

width: width of the image (in cm)

height: height of the image (in cm)

flags: you can specify one or more flags, chosen between:

P	proportional
T	image alignment to the top of text (only with Explorer)
M	image alignment to the middle of text (only with Explorer)
B	image alignment to the bottom of text (only with Explorer)
L	image alignment to the left of the rectangle, text flushing right (only with Explorer)
R	image alignment to the right of the rectangle, text flushing left (only with Explorer)
E	image alignment to the left (under other images with L flag), text flushing right (only with Explorer)
I	image alignment to the right (under other images with R flag), text flushing left (only with Explorer)
C	the replacement of the key with the image is made in a case-sensitive way
D	this image is not resized when a F flag is used in the HTMLTEXT directive
H	this image is drawn over the text
A	margins are also adjusted when an F flag is used in the HTMLTEXT directive
X	do not smooth the image
G	you can add a variable text in the key (before the last character) to be shown over the image
U	the text added with G flag is drawn under the image

angle: the angle of the rotation for the image

margin top: the size of the top margin, in cm (the default is no margin)

margin left: the size of the left margin, in cm (the default is no margin)

margin right: the size of the right margin, in cm (the default is no margin)

margin bottom: the size of the bottom margin, in cm (the default is no margin)

alpha: level of transparency of the image, from 0 (full transparent) to 100 (full solid); if omitted, the level is set to 100 (full solid).

htmlfont: the text (added with G flag) is drawn with this font, defined by a HTMLFONT directive (see page 123)

pos X: the horizontal position (in %) of the text (added with G flag); if omitted, is set to 50 (the center of the image)

pos Y: the vertical position (in %) of the text (added with G flag); if omitted, is set to 50 (the center of the image)

CSS: this text is added to the image definition as a CSS HTML style

Example:

```
HTMLIMAGE = 1, "(one)", "image.bmp", 1, 1, P
HTMLTEXT = 1, "Test (one)", 0, 0, 6, 9, #FFFFFF, 0, T
```

HTMLKEY

With this directive, you can create words that are replaced by longer texts in HTMLTEXT directive (see page 127). If you leave empty the 3rd parameter, the key is deleted instead.

Syntax:

HTMLKEY = “range”, “key”, “text”, *htmlfont*, *flags*, “replace”, “from”, “to”

“**range**”: a set of cards

“**key**”: a string that is searched and replaced with text parameter

“**text**”: a string that replaces the **key** parameter

htmlfont: add start and end tags for a font defined by an HTMLFONT directive (see page 123)

flags: you can specify one or more of these flags:

C	the replacement of the key with the text is made in a case-sensitive way
R	the key searched can be specified using a regular expression
F	the font is applied only to the replaced text found with R flag
Z	forces the text on a single line
D	delete the key

replace: using the R flag, this is the character that, in “text” parameter, is replaced with the found text

from: in the result found with R flag, this text is replaced with the text in the next parameter; it can also be a sequence of texts

to: in the result found with R flag, this is the text that replaces the text specified in the previous parameter; it can also be a sequence of texts

Example:

```
HTMLFONT = fnt0, Arial, 10, , #000000
HTMLFONT = fnt1, Arial, 16, , #000000
HTMLFONT = fnt2, Arial, 16, B, #FF0000
HTMLKEY = 1, (test), "only (one) word", fnt1
HTMLKEY = 1, (one), "one", fnt2
HTMLTEXT = 1, "Test (test)", 0, 0, 6, 9, #FFFFFF, 0, E, 100, fnt0
```

HTMLLANG

With this directive, you specify the language that is used for the automatic hyphenation, when the H flag is used in HTMLFONT (see page 123).

Syntax:

HTMLLANG = language

language: a string that define the language used (en, fr, de, it, etc.)

Example:

HTMLLANG = it

HTMLMARGINS

This directive adds the settings for margins and vertical alignment to an existing tag (that was created with HTMLFONT directive, see page 123) to be used in HTMLTEXT directive (see page 127); this directive works only with E flag in HTMLTEXT (MS Explorer).

Syntax:

HTMLMARGINS = "html tag", margin top, *margin left*, *margin right*, *margin bottom*, *paragraph alignment*, *line spacing*, *cell width*, *cell height*, *stretch hor.*, *stretch ver.*, *angle*

Parameters:

"html tag": a name used for referencing the font

margin top: the size of the top margin, in cm

margin left: the size of the left margin, in cm

margin right: the size of the right margin, in cm

margin bottom: the size of the bottom margin, in cm

paragraph alignment: the text's vertical alignment, values accepted are:

top	top aligned
center	centered
bottom	bottom aligned

line spacing: the text's line spacing in %, the default is 100 is for a single line

cell width: the width of a table cell, in cm (it works only when T flag is used in HTMLFONT)

cell height: the height of a table cell, in cm (it works only when T flag is used in HTMLFONT)

stretch hor.: the font is shrunk horizontally (if the value is less than 100) or stretched (if the value is greater than 100)

stretch ver.: the font is shrunk vertically (if the value is less than 100) or stretched (if the value is greater than 100)

angle: the angle of rotation of the text

Example:

```
HTMLFONT = alpha, Arial, 32, , #000000
HTMLMARGINS = alpha, 0.5, 1, 1
HTMLTEXT = 1, "This is a test", 0, 0, 100%, 100%, #FFFFFF, 0, EB, 100, alpha
```

*Note: using 100 as **line spacing** gives a different result from leaving that parameter empty, it is a behavior of HTML.*

HTMLTEXT

This directive prints a text, using HTML format, in the cards specified by a range. This directive is useful if you want to print a text with multiple size, font, attributes, colors and so on. For expressions, you must include them in double curly parentheses {{ ... }}. You can add also one or more images, using a keyword(s), coded with the HTMLIMAGE directive (see page 125).

Syntax:

HTMLTEXT = “range”, “text”, pos x, pos y, width, height, *html color*, *angle*, *flags*, *alpha*, *htmlfont1*, *htmlfont2*, *separator*, *width factor*, *height factor*

Parameters:

“**range**”: a set of cards

“**text**”: the HTML text to be printed

pos x: horizontal position (in cm)

pos y: vertical position (in cm)

width: width of the text’s rectangle (in cm)

height: height of the text’s rectangle (in cm)

html color: background color for text

angle: angle of text rotation, you must specify 0 for no rotation

flags: you can specify one or more flags, chosen between:

T	Transparent background for text
H	Horizontal mirror
V	Vertical mirror
I	HTML rendering with old internal engine (default)
A	HTML rendering with new internal engine
E	HTML rendering with MS Explorer
K	HTML rendering with Google Chrome
2	Render a x2 image (better use the OVERSAMPLE directive)
4	Render a x4 image (better use the OVERSAMPLE directive)
8	Render a x8 image (better use the OVERSAMPLE directive)
R	Vertical text
B	Transparent background, better rendering of png, does not work with I flag
F	The text is reduced to fit the rectangle, does not work with I flag
S	The text is reduced to fit the rectangle and the size is saved for the next cards, does not work with I flag
J	The text is enlarged to fit the rectangle, does not work with I flag
G	The width is reduced to set the lines with the same length
M	The images are resized with the text, works only with F flag
L	TEXTLIMIT variables are calculated more accurately, does not work with I flag
O	Replace tags also between < and >
U	The fonts in 12 th parameter are applied sequentially
C	Clear page after rendering, works only with E flag
N	Use always a new instance, works only with E flag
Y	Keep the HTML file on disk, for debugging, does not work with internal engines
Z	Instead of a temporary file on disk, use RAM, works only with E flag
X	Instead of a temporary file on disk, use RAM (alternate method), works only with E flag
Q	Instead of a temporary file on disk, use RAM (alternate method), works only with E flag

alpha: level of transparency of text, from 0 (full transparent) to 100 (full solid). If omitted, the level is set to 100 (full solid). You can also specify an angle for the transparency, with the format **level@angle**; in this case, the level of transparency is the starting level, ending with 0 (full transparent)

htmlfont1: add to the whole text the start and end tags for a font defined by an HTMLFONT directive (see page 123)

htmlfont2: add to each paragraph the start and end tags for a font defined by an HTMLFONT directive (see page 123)

separator: you can specify the separator of each paragraph (if not specified, it is
)

width factor: if you specify a number, the text is horizontally stretched (the default is 100)

height factor: if you specify a number, the text is vertically stretched (the default is 100)

Example:

```
[HTML] = "(text) example<br>(image) example<br>(earth) "  
HTMLFONT = fnt, Arial, 10, , #000000  
HTMLFONT = fntb, Arial, 10, B, #000000  
HTMLKEY = 1, (text), "Text", fntb  
HTMLKEY = 1, (image), "Image", fntb  
HTMLIMAGE = 1, (earth), earth.jpg, 6, 6  
HTMLTEXT = 1, [HTML], 0, 0, 6, 9, #FFFFFF, 0, E, 100, fnt
```

Result: Figure 33



Figure 33

ICON

This directive assigns one or more characters (a “key”) to an image, to be used later with an ICONS directive (see page 129). Note that if the key is longer than one character (the default), it must be specified as 14th parameter in ICONS.

Syntax:

ICON = “range”, key, “image file”, *width factor*, *height factor*

Parameters:

“range”: a set of cards

key: one or more characters used to identify the image (like “A” or “001”)

“image file”: an existent image file (eventually with a path), formats allowed are bmp, gif, png, jpg, and tif

width factor: the width of the image is adjusted with this factor, a value larger than 100 enlarge the width of the image, a value less than 100 shrink the width of the image (if not specified, the width factor of the image is 100)

height factor: the height of the image is adjusted with this factor, a value larger than 100 enlarge the height of the image, a value less than 100 shrink the height of the image (if not specified, the height factor of the image is 100)

Example:

```
ICON = "1-10", A, "c:\images\image1.jpg"  
ICON = "1-10", B, "c:\images\image2.jpg"  
ICON = "1-10", C, "c:\images\image3.jpg"
```

ICONS

This directive prints a number of images in a rectangular area, like a multi-image PATTERN directive (see page 161), the “keys” parameter identifies the images used, defined before with some ICON directives (see page 129), note that by default each key is one character long, but you can have a longer key by specifying the length in the 14th parameter. For example, if you write:

```
ICON = "1-10", A, "c:\images\image1.jpg"  
ICON = "1-10", B, "c:\images\image2.jpg"  
ICON = "1-10", C, "c:\images\image3.jpg"
```

You can use a key of “ABC” in an ICONS line to print the three images all together in a rectangular area. This directive is useful when you must convert to images an output from the combination/permutation engine. You can also use these special characters:

- < adds a *backspace* and draw two images in the same place; for example, a key like “P<2” means that the image assigned to “2” is printed over the image assigned to “P”
- > adds a *newline*; for example, a key like “A>BB” draws first the image “A”, and two images “B” in a new line, i.e., the three images are arranged in a triangle pattern

- _ the image corresponding to the next key is shown in the current icon space, merged with the next. For example, `_A` means that image A is shown in the merged space of two icons; `__A` means that image A is shown in the merged space of three icons

Note: if you have a key longer than one character, these special characters must be replicated as well (i.e., with a key length of two, the special characters become "<<", ">>", "___".

Syntax:

ICONS = "range", keys, pos x, pos y, width, height, obj width, obj height, *angle, flags, horizontal alignment, vertical alignment, alpha, key length, width factor, height factor, frames*

Parameters:

"range": a set of cards

keys: a string, composed by characters assigned to images with ICON directives

pos x: horizontal position (in cm)

pos y: vertical position (in cm)

width: width of the rectangle in which the images are printed (in cm)

height: height of the rectangle in which the images are printed (in cm)

obj width: width of the single image to be printed (in cm)

obj height: height of the single image to be printed (in cm)

angle: angle of image rotation, if not specified it is assumed to be 0 (for no rotation)

flags: in this parameter, you can specify a special behavior for images, possible values are:

T	Transparent
A	Anti-aliasing
R	Reverse, reversing the filling order of pattern's elements (from bottom to top)
N	Use PNG transparency
P	Proportional
C	Extends the image cropping the borders
V	Vertical pattern
W	Distribute icons in width
H	Distribute icons in height
L	Keeps icons on a single line
X	Use variable length for the key (the length parameter is not used)

horizontal alignment: the images' horizontal alignment in the rectangle, values accepted are:

LEFT	left aligned
CENTER	centered (the default)
RIGHT	right aligned

vertical alignment: the images' vertical alignment in the rectangle, values accepted are:

TOP	top aligned
CENTER	centered (the default)
BOTTOM	bottom aligned

alpha: level of transparency of text, from 0 (full transparent) to 100 (full solid). If omitted, the level is set to 100 (full solid). You can also specify an angle for the transparency, with the format **level@angle**; in this case, the level of transparency is the starting level, ending with 0 (full transparent)

key length: the default length of the character string utilized for key is one character, but a different length can be specified here, the "keys" parameter length must be a multiple

width factor: the width of the space for an image is adjusted with this factor, a value larger than 100 enlarge the width of the space, a value less than 100 shrink the width of the space (if not specified, the width factor of the space is 100)

height factor: the height of the space for an image is adjusted with this factor, a value larger than 100 enlarge the height of the space, a value less than 100 shrink the height of the space (if not specified, the height factor of the space is 100)

frames: a list of frames (optional) in which the icons are drawn (one icon for each frame)

Example:

```
RECTANGLE = 1, 0, 0, 6, 6, #0000FF
ICON = 1, A, "c:\images\dot_red.gif"
ICON = 1, B, "c:\images\dot_blue.gif"
ICON = 1, C, "c:\images\dot_black.gif"
ICONS = 1, BAC, 0, 0, 6, 6, 2, 2, 0, T, CENTER, CENTER
```

Result: Figure 34

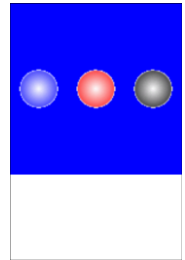

Figure 34

IF

The IF...ENDIF structure can be used to create sections of code that must be executed only if are verified some conditions.

Syntax:

```
IF = value1 operator value2
...
ELSEIF = value3 operator value4
...
ELSEIF = value5 operator value6
...
ELSE
...
ENDIF
```

Parameters:

value: a string, number, label, or expression that can be evaluated

operator: the condition is evaluated using the two values and this operator, you can use one operator from this list:

=	value1 and value2 are equal
>	value1 is major than value2
<	value1 is minor than value2
>=	value1 is major or equal than value2
<=	value1 is minor or equal than value2
<>	value1 and value 2 are different
@	value1 is contained into value2
#	value1 is not contained into value2

More than one test can be combined using Boolean logic, every test must be enclosed in parenthesis, and these are the accepted keywords:

```
_TRUE_
_FALSE_
_NOT_
_AND_
_OR_
```

If in an expression there are more than one logic operator, they are evaluated with these priorities (if they have the same priorities, they are evaluated from left to right):

- 1) `_NOT_`
- 2) `_AND_`
- 3) `_OR_`

Examples:

```
; choose a value between R, E and T
[check] = R
IF = [check] = R
    RECTANGLE = 1, 0, 0, 6, 9, #0000FF
ELSEIF = [check] = E
    ELLIPSE = 1, 0, 0, 6, 9, #00FF00
ELSEIF = [check] = T
    TRIANGLE = 1, 3, 0, 6, 9, 0, 9, #FF0000
ELSE
    RECTANGLE = 1, 0, 0, 6, 9, #000000
ENDIF
```

```
; complex logic
if=([a]=1) _AND_ _NOT_ ([b]=3)
```

```
; in this example, the _AND_ operator is evaluated first
if=([a]=1) _OR_ ([b]=1) _AND_ ([c]=1)
```

```
; in this example, the _OR_ operator is evaluated first
if=(([a]=1) _OR_ ([b]=1)) _AND_ ([c]=1)
```

Note: if you want to use a sequence as argument for the IF directive, you must extract an element using the ? operator (and \$ for the number of the current card) inside an expression (with curly brackets). For example:

```
IF = {sequence?$} = element
```

IMAGE

This directive can be used to add an external image to a range of cards.

Syntax:

IMAGE = range, image file, pos x, pos y, width, height, angle, *flag*, *alpha*, *texture width*, *texture height*, *skew x*, *skew y*, *img width*, *img height*, *loc x*, *loc y*, *copy x*, *copy y*

Parameters:

range: a set of cards (the standard rules about ranges will be applied)

image file: an existent image file (eventually with a path), formats allowed are bmp, gif, png, jpg, and tif

pos x: horizontal position (in cm)

pos y: vertical position (in cm)

width: width of the image (in cm)

height: height of the image (in cm)

angle: angle of image rotation, can be 0 for no rotation



Figure 35

These are the required parameters. This directive can be used for a background on all your cards, or a logo on top-right, or a centered image. Simply specify range, image, position, and angle. For example:

```
IMAGE = 1, "c:\images\earth.jpg", 0, 0, 6, 9, 0
```

Result: Figure 35

Note that the image will fill the destination rectangle, the standard behavior of this command is resizing the original image and altering the aspect ratio for width and height. If you want to maintain the original aspect you must use a flag, as additional parameter.

```
RECTANGLE = 1, 0, 0, 6, 9, #0000FF  
IMAGE = 1, "c:\images\earth.jpg", 0, 0, 6, 9, 0, P
```

Result: Figure 36



Figure 36

flag: in this parameter you can specify any, some or all these letters:

- P Proportional
- A Anti-aliasing
- G Grayscale
- H Horizontal mirror
- V Vertical mirror
- T Transparent
- X Texture
- N Use PNG transparency
- R Do not adjust size for rotated images
- D Use DPI from image file
- C Extends the image cropping the borders
- I Reads the EXIF tags for orientation from file
- J Use an alternate library for loading images in jpeg format
- U Align the image to the upper boundary of the rectangle (with P/C flag)
- E Align the image to the right boundary of the rectangle (with P/C flag)
- S Align the image to the lower boundary of the rectangle (with P/C flag)
- W Align the image to the left boundary of the rectangle (with P/C flag)
- O Crop the source image (x, y, width, and height specified in parameters from 10th to 13th)

With the “P” flag, the image will be resized maintaining the original aspect ratio. The previous background remains unchanged in the zone not occupied by the image.

With the “A” flag, to the image will be applied a smoothing filter. There are no other settings related to that parameter.

With the “G” flag, the image will be reduced to tones of gray (256 levels maximum). There are no other settings related to that parameter.

With the “H” or “V” flags, the image will be mirrored in the corresponding direction (these flags may be used both with the same image).

If the “T” flag is used, the image will be rendered with a transparent color. If the CHROMAKEY directive was not used before, the transparent color is assumed to be the first pixel of the image (top left pixel). With the CHROMAKEY directive (see relative entry, page 94), you can specify a pixel from another corner, or directly a color.

With the “X” flag, the image is used to fill the destination space (see texture width/height parameters).

With the “N” flag, the image is loaded reading the transparency information (only PNG format).

Without the “R” flag, a rotated image is stretched to be fully included in the destination rectangle, with this flag, the directive maintains the original size for the rotated image.

With the “D” flag, the size of the image is adjusted reading the DPI from the file (only with BMP, PNG, and JPG formats).

With the “U”, “E”, “S”, and “W” flags (to be used with P/C flag), the image is aligned to the relative boundaries of the rectangle (if not specified, the image is centered).

If the “O” flag is specified, only the rectangle indicated by the 10th to 13th parameters is read from the original image (note that with this flag, the texture and skew options are not usable).

alpha: level of transparency of image, from 0 (full transparent) to 100 (full solid). If omitted, the level is set to 100 (full solid). You can also specify an angle for the transparency, with the format **level@angle**; in this case, the level of transparency is the starting level, ending with 0 (full transparent), for example:

```
RECTANGLE = 1, 0, 0, 6, 9, #0000FF
IMAGE = 1, "c:\images\earth.jpg", 0, 0, 6, 9, 0, P, 100@90
```

Result: Figure 37



Figure 37

texture width: width of the texture (in cm), used only with “X” flag, if omitted the default is the image’s width

texture height: height of the texture (in cm), used only with “X” flag, if omitted the default is the image’s height

This is an example of using a texture to fill a space on a card (note, the alpha-channel is specified because you cannot leave the parameter empty), with texture size 1x1 cm (remember, the card is 6x9 cm):

```
IMAGE = 1, "c:\images\earth.jpg", 0, 0, 6, 9, 0, X, 100, 1, 1
```

Result: Figure 38



Figure 38

skew x: draw the image shifted horizontally (to the right for positive number, to the left for negative), the value 1 is the image’s width (you can use a decimal value)

skew y: draw the image shifted vertically (to the bottom for positive number, to the top for negative), the value 1 is the image’s height (you can use a decimal value)

This is an example for the skew effect (horizontal, value 0.5), note that the second image was vertically mirrored and printed with an alpha-channel value of 60.

```
RECTANGLE = 1, 0, 0, 6, 9, #000000
IMAGE = 1, "c:\images\earth.jpg", 0, 0, 6, 6, 0
IMAGE = 1, "c:\images\earth.jpg", 0, 6, 6, 3, 0, V, 60, 0, 0, 0.5, 0
```

Result: Figure 39



Figure 39

img width: if this parameter is specified, the image is not enlarged to the whole rectangle, but instead is drawn with this width (in cm)

img height: if this parameter is specified, the image is not enlarged to the whole rectangle, but instead is drawn with this height (in cm)

loc x: if this parameter is a positive value, the image is positioned at that % of width, with a width equal to the parameter **image width**; if this parameter is a negative one, the image is split horizontally at that % of his width, and the two halves are positioned at the edge of the rectangle

loc y: if this parameter is a positive value, the image is positioned at that % of height, with a height equal to the parameter **image height**; if this parameter is a negative one, the image is split vertically at that % of his height, and the two halves are positioned at the edge of the rectangle

copy x: if the image is split horizontally, the empty gap between the two halves is filled with a % of the image, starting from the cut point

copy y: if the image is split vertically, the empty gap between the two halves is filled with a % of the image, starting from the cut point

Tip: you can choose a name (and path) from a Windows standard dialog, clicking on the button “Insert” and choosing the menu voice “Image”.

Tip: if you drag and drop an image file in nanDECK's window, an IMAGE line is added with the path and filename of the image.

IMAGEENC

This directive is used to start an IMAGEENC...ENDIMAGEENC structure, for including an image as encoded text directly into the script. You can encode an image file with a click on the “Insert >” button and choosing the “Image as encoding” option.

Syntax:

IMAGEENC = filename

Parameter:

filename: the filename of the image that is created with the encoded data

Example:

```
IMAGEENC = sun.png
iVBORw0KGgoAAAANSUheUgAAAsUAAALFCAYAAAARY54YAAACXBIWXMAAC4jAAAUlwF4pt92AAAZIUlE
QVR42u3WWXYcOQxFQXv/
...
AwBQnigGAKA8UQwAQHmiGACA8kQxAADliWIAAMoTxQAAlCeKAQAo719v+uorjuQNjgAAAABJRU5ErkJg
gg==
ENDIMAGEENC
```

IMAGEFILTER

This directive sets the filter and blend routines using when images are loaded and resized in a card (with IMAGE, ICONS, PATTERN, HTMLTEXT/HTMLFILE, RTFTEXT/RTFFILE, and OVERSAMPLE directives). If not specified, the default filter is LINEAR, and the default blend is SOLID.

Syntax:

IMAGEFILTER = filter name, *blend name*, *mask file*

Parameters:

filter name: the filter may be one of the following:

```
NEAREST
DRAFT
LINEAR
COSINE
SPLINE
LANCZOS
MITCHELL
```

blend name: the blending routine may be one of the following:

```
SOLID
ADD
SUB
MOD
DIV
DARKEN
LIGHTEN
SCREEN
DODGE
BURN
```

DIFFERENCE
EXCLUSION
AVERAGE
SCALE
BLENDADD
BLENDMOD

mask file: every image is drawn using the transparency layer of the png file indicated as a parameter

Example:

`IMAGEFILTER=LANCZOS`

IMAGELIMIT

This directive fills four variables with the values of the coordinates that delimit an image, specifying a background color, optionally with a threshold (zero for detecting every color different from the background, 100 for a difference between total white and total black). You can use these variables in other commands.

Syntax:

`IMAGELIMIT = "range", pos x, pos y, width, height, html color, threshold`

The four variables are:

PL (left)
PR (right)
PT (top)
PB (bottom)

Parameters:

"range": a set of cards

pos x: horizontal position (in cm)

pos y: vertical position (in cm)

width: width of the area (in cm)

height: height of the area (in cm)

html color: background color for identify the image

threshold: this parameter sets the difference between the background color and the color detected as part of the image

IMAGESIZE

This directive reads an image and writes in two variables the image's width and height (in pixel).

Syntax:

`IMAGESIZE = "range", "image file"`

The variables are:

IW image's width
IH image's height

Parameters:

"range": a set of cards

“Image file”: an existent image file (eventually with a path), formats allowed are bmp, gif, png and jpg

Example:

```
IMAGESIZE = 1, "c:\images\earth.jpg"  
IMAGE = 1, "c:\images\earth.jpg", 0, 0, 6, 6, 0, P  
FONT = Arial, 16, , #000000  
TEXT = 1, "Width={IW}" ,0 ,7 ,6 ,1 ,left, center  
TEXT = 1, "Height={IH}" ,0 ,8 ,6 ,1 ,left, center
```

Result: Figure 40



Figure 40

INCLUDE

This directive includes another script file in the current script, as if it were copied and pasted. You can omit the path if the included file is in the same directory of the including script.

Syntax:

```
INCLUDE = "filename"
```

Examples:

```
INCLUDE = "c:\test\alpha.txt"
```

```
INCLUDE = beta.txt
```

Tip: you can choose a name (and path) from a Windows standard dialog, clicking on the button “Insert” and choosing the menu voice “Include”.

INPUTCHOICE

With this directive, the user can input a variable text that can be used as a label value, this text can be chosen between the values from a sequence. The text confirmed is stored to a file with the same name of the script and “ini” for extension, or can be saved to a specific configuration file, to be loaded in a subsequent execution.

Syntax:

```
INPUTCHOICE = “label”, “description”, “default”, “values”
```

Parameters:

“label”: the label for storing input text

“description”: a text shown before the input box

“default”: starting value for the label

“values”: a sequence with the available choices

Example:

```
INPUTCHOICE = "color", "Choose a color, please:", "Red", "Red|Green|Blue"
```

This is the resulting input form:

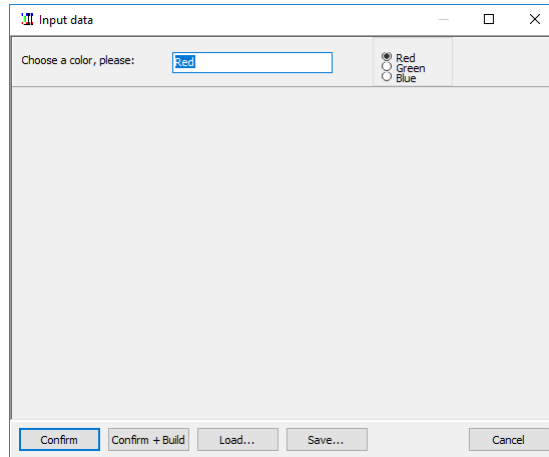

INPUTLIST

With this directive, the user can input a variable text that can be used as a label value, this text can be chosen between the values from a sequence. The text confirmed is stored to a file with the same name of the script and “ini” for extension, or can be saved to a specific configuration file, to be loaded in a subsequent execution.

Syntax:

```
INPUTLIST = “label”, “description”, “default”, “values”
```

Parameters:

“**label**”: the label for storing input text

“**description**”: a text showed before the input box

“**default**”: starting value for the label

“**values**”: a sequence with the available choices

Example:

```
INPUTLIST = "color", "Choose a color, please:", "Red", "Red|Green|Blue"
```

This is the resulting input form:

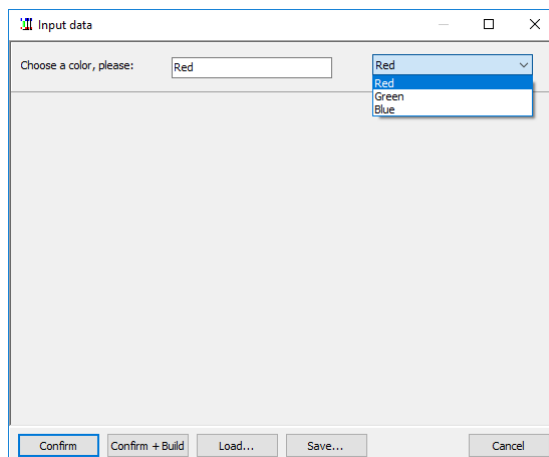

INPUTNUMBER

With this directive, the user can input a variable integer number that can be used as a label value, this number can be chosen between a minimum and a maximum value. The number confirmed is stored to a file with the same name of the script and “ini” for extension, or can be saved to a specific configuration file, to be loaded in a subsequent execution.

Syntax:

```
INPUTNUMBER = “label”, “description”, default, min, max
```

Parameters:

“**label**”: the label for storing input number

“**description**”: a text shown before the input box

default: starting value for the number

min: minimum value for the number

max: maximum value for the number

Example:

```
INPUTNUMBER = "name", "Choose a number, please:", 5, 1, 10
```

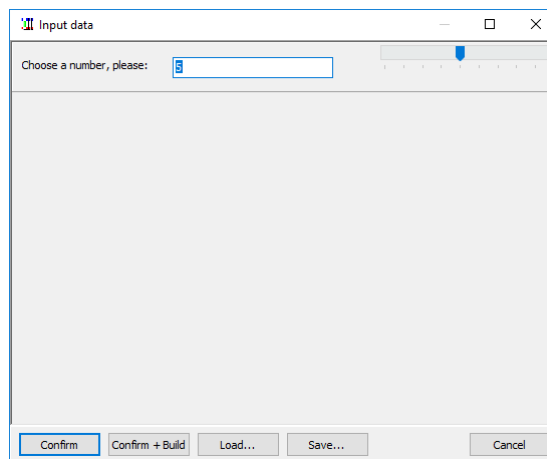

INPUTTEXT

With this directive, the user can input a variable text that can be used as a label value. The text confirmed is stored to a file with the same name of the script and “ini” for extension, or can be saved to a specific configuration file, to be loaded in a subsequent execution.

Syntax:

```
INPUTTEXT = “label”, “description”, “default”, flags
```

Parameters:

“**label**”: the label for storing input text

“**description**”: a text showed before the input box

“**default**”: starting value for the label

flags: in this parameter, you can add a flag for a special effect, like:

- F The program shows a button for browsing a file (to be added in the text field)
- G The program shows a button for browsing a graphical file (to be added in the text field)
- C The program shows a button for selecting a color
- R The program shows a button for selecting a color gradient

Example:

```
INPUTTEXT = "name", "Input you name, please:", "John"
```

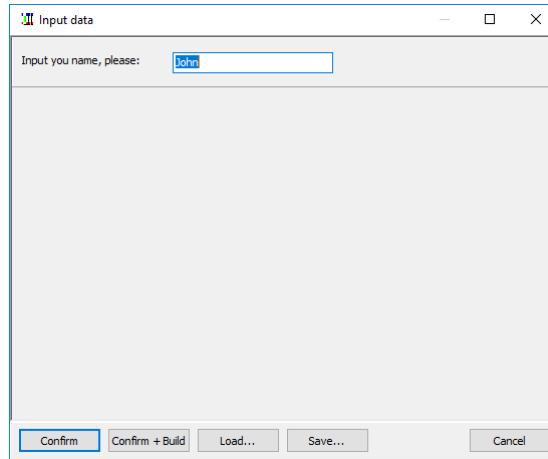

LABELMERGE

When you define a label that is already defined, the default behavior is that the current value (both single elements and sequences) replaces the existing. With this directive you change that behavior and appending instead the current value to the existing one (creating a longer sequence).

Syntax:

LABELMERGE = switch

Parameter:

switch: values accepted are:

- ON a new sequence is created, appending the current value to the former one
- OFF the current value replaces the former one (this is the default behavior)

Note: this setting is valid also for labels read from linked files.

LAYER

The directives between a structure LAYER...ENDLAYER are drawn in a separate card, then printed on the main card (or stored for a later use). Since the drawing directives like the RECTANGLE does not support alpha transparency, they can be drawn in this mode with a LAYER structure. If you specify the 5th parameter the layer is stored in memory (using that parameter as a name) and drawn later with a LAYERDRAW directive, if the name is not specified, the layer is drawn immediately.

Syntax:

LAYER = *alpha, offset x, offset y, angle, name, width, height, flags*

Parameters:

alpha: level of transparency of the layer, from 0 (full transparent) to 100 (full solid). If omitted, the level is set to 100 (full solid). You can also specify an angle for the transparency, with the format **level@angle**; in this case, the level of transparency is the starting level, ending with 0 (full transparent)

offset x: the horizontal offset of layer

offset y: the vertical offset of layer

angle: the angle of rotation of layer

name: the name of the layer

width: a zoom factor for stretching the image horizontally (100 is the original size)

height: a zoom factor for stretching the vertically the image (100 is the original size)

flags: you can specify one or more of these flags:

C use the layer in the canvas (the default is in the cards)

Example:

```
LAYER = 50
RECTANGLE = 1, 3, 0.5, 3, 8, #FF0000
FONT = Arial, 24, T, #000000
TEXT = 1, Alpha, 3, 5, 3, 5
ENDLAYER
```

LAYERDRAW

The directive draws a layer in a range of cards. The layer drawn is specified using its name (defined by the 5th parameter in the LAYER directive), and it must have been created before with a LAYER...ENDLAYER structure. You can also specify a list of layers, separated by commas.

Syntax:

LAYERDRAW = “range”, name, *alpha*, *offset x*, *offset y*, *angle*, *width*, *height*

Parameters:

“range”: a set of cards

name: the name of the layer(s)

alpha: level of transparency of the layer, from 0 (full transparent) to 100 (full solid). If omitted, the level is set to 100 (full solid). You can also specify an angle for the transparency, with the format **level@angle**; in this case, the level of transparency is the starting level, ending with 0 (full transparent)

offset x: the horizontal offset of layer

offset y: the vertical offset of layer

angle: the angle of rotation of layer

width: a zoom factor for stretching the image horizontally (100 is the original size)

height: a zoom factor for stretching the vertically the image (100 is the original size)

LIMIT

This directive fills four variables with the coordinates of latest drawn object’s boundaries (in cm), from various command (*). You can use these variables in other commands.

Syntax:

LIMIT = “range”

The four variables are:

PL (left)
PR (right)
PT (top)
PB (bottom)

Parameters:

“**range**”: a set of cards

(*) This directive works with this list of directives:

BEZIER
BEZIERS
BUTTON
CIRCLE
COPY
ELLIPSE
GRID
HEXGRID
HTMLFILE
HTMLTEXT
ICONS
IMAGE
LINE
LINERECT
PATTERN
PIE
POLYGON
RECTANGLE
RHOMBUS
ROUNDRECT
RTFFILE
RTFTEXT
STAR
TEXT
TRACK
TRACKRECT
TRIANGLE

LINE

This directive draws a line from a point (x1, y1) to another point (x2, y2).

Syntax:

LINE = “range”, pos x1, pos y1, pos x2, pos y2, *html color*, *thickness*, *pattern*, *end arrow*, *start arrow*, *end angle*, *start angle*, *distance*

Parameters:

“**range**”: a set of cards

pos x1, pos y1: coordinates of first point (in cm)

pos x2, pos y2: coordinates of second point (in cm)

html color: color of the line, in the same format used for HTML (black, if not specified). You can also use a gradient

thickness: thickness of the line (in cm), if omitted, the line is 1 pixel wide

pattern: a pattern for the line, this pattern can be composed of:

O dot
D dash
S space

These letters can be repeated, for example “OSDSOS” is a valid pattern

end arrow: width of the arrow (in cm), if omitted (or zero) there is no arrow at the end of the line

start arrow: width of the arrow (in cm), if omitted (or zero) there is no arrow at the start of the line

end angle: the angle (in degrees) of the spokes of the arrow at the end of the line

start angle: the angle (in degrees) of the spokes of the arrow at the start of the line

distance: distance between the pattern elements (in cm), if omitted, the thickness is used

Note: if end/start angle is negative, the arrow is drawn as a full triangle (with three lines instead of two).

Example:

```
LINE = 1, 1, 1, 5, 1, #0000FF#FF0000@0  
LINE = 1, 1, 2, 5, 2, #0000FF#FF0000@0, 0.05  
LINE = 1, 1, 3, 5, 3, #0000FF#FF0000@0, 0.1  
LINE = 1, 1, 4, 5, 4, #0000FF#FF0000@0, 0.15  
LINE = 1, 1, 5, 5, 5, #0000FF#FF0000@0, 0.2  
LINE = 1, 1, 6, 5, 6, #0000FF#FF0000@0, 0.25  
LINE = 1, 1, 7, 5, 7, #0000FF#FF0000@0, 0.3  
LINE = 1, 1, 8, 5, 8, #0000FF#FF0000@0, 0.35, OSDSOS
```

Result: Figure 41



Figure 41

LINERECT

This directive draws a line from a vertex of a rectangle to the opposite vertex.

Syntax:

LINERECT = “range”, pos x, pos y, width, height, *html color*, *thickness*, *pattern*, *end arrow*, *start arrow*, *flags*, *end angle*, *start angle*, *distance*

Parameters:

“range”: a set of cards

pos x: horizontal position (in cm)

pos y: vertical position (in cm)

width: width of the rectangle (in cm)

height: height of the rectangle (in cm)

html color: color of the line, in the same format used for HTML (black if not specified). You can also use a gradient

thickness: thickness of the line (in cm), if omitted, the line is 1 pixel wide

pattern: a pattern for the line, this pattern can be composed of:

O dot
D dash

S space

These letters can be repeated, for example “OSDSOS” is a valid pattern

end arrow: width of the arrow (in cm), if omitted (or zero) there is no arrow at the end of the line

start arrow: width of the arrow (in cm), if omitted (or zero) there is no arrow at the start of the line

flags: you can specify one or more of these flags to choose which lines to draw:

T top side
R right side
B bottom side
L left side
H middle horizontal
V middle vertical
D diagonal from top-left to bottom-right
G diagonal from top-right to bottom-left

If you do not specify a flag, the default is top-left to bottom-right diagonal.

end angle: the angle (in degrees) of the spokes of the arrow at the end of the line

start angle: the angle (in degrees) of the spokes of the arrow at the start of the line

distance: distance between the pattern elements (in cm), if omitted, the thickness is used

Note: if end/start angle is negative, the arrow is drawn as a full triangle (with three lines instead of two).

Example:

```
LINERECT = 1, 1, 1, 4, 0, #0000FF#FF0000@0  
LINERECT = 1, 1, 2, 4, 0, #0000FF#FF0000@0, 0.05  
LINERECT = 1, 1, 3, 4, 0, #0000FF#FF0000@0, 0.1  
LINERECT = 1, 1, 4, 4, 0, #0000FF#FF0000@0, 0.15  
LINERECT = 1, 1, 5, 4, 0, #0000FF#FF0000@0, 0.2  
LINERECT = 1, 1, 6, 4, 0, #0000FF#FF0000@0, 0.25  
LINERECT = 1, 1, 7, 4, 0, #0000FF#FF0000@0, 0.3  
LINERECT = 1, 1, 8, 4, 0, #0000FF#FF0000@0, 0.35, OSDSOS
```

Result: Figure 42



Figure 42

LINK

This directive is used to link data, written as a text file (CSV format) or a spreadsheet (with **xls**, **xlsx**, or **ods** extensions), with the current script. The data linked are referenced in the script as sequences. If the fields’ names are omitted, the fields are referenced using the names contained in the first row of the file.

For text files, the character used to separate fields’ data can be changed using the LINKSEP directive (see page 151). See also the LINKMULTI directive (page 149) if you need to duplicate the data rows, and the “Linked data editor” chapter (page 70).

For spreadsheet files, you can specify the sheet name after the filename, separated by a “!” character (if you omit the sheet name, the program reads the first sheet).

Syntax for text files:

LINK = “filename”, “field1”, “field2”, ... “fieldN”

A sequence of file names can also be specified in the 1st parameter. If you omit the “filename” parameter, the program reads the data directly from the script file, until it reads a ENDLINK directive (see page 109).

Syntax for spreadsheet files:

LINK = "filename!sheet", "field1", "field2", ... "fieldN"

*Note: accented or foreign characters are translated in HTML codes, to be used with HTMLTEXT (see page 127). If you want to disable this feature, add a **LINKUNI=OFF** line (see page 153) before the LINK line.*

Note: if you indicate the same field names on multiple LINK lines, empty elements will be added to the sequences if those fields are not present in a sheet.

Tip: you can choose a name (and path) from a Windows standard dialog, clicking on the button "Insert" and choosing the menu voice "Link".

Tip: if you drag and drop a spreadsheet file in nanDECK's window, a LINK line is added with the path and filename of the spreadsheet.

If the spreadsheet file does not exist, the program asks if you want to create it (with the names of the fields specified in the line as the parameters field1, field2, etc).

Examples:

```
LINK = "c:\test\data01.txt"
```

```
LINK = "c:\test\data02.txt", size, speed, weight
```

```
LINK = "c:\test\data01.xls"
```

```
LINK = "c:\test\data01.xls!sheet2"
```

With the 2nd example, in the script these fields are referenced as [size], [speed] and [weight].

Example of file "data02.txt":

```
1, 2, 3  
4, 5, 6  
7, 8, 9  
10, 11, 12
```

The program will translate the data file in these sequences:

```
[size]=1|4|7|10  
[speed]=2|5|8|11  
[weight]=3|6|9|12
```

You can also link a Google Sheet document, using the ID of the file instead of "filename" parameter, but you must share it first, following these steps:

- select the file in Google Drive web page
- click the Share icon (the icon with the "little man" in top-right button bar)
- click the dropdown menu below "Link sharing on" in the window
- select a link sharing option, one of the "Anyone with the link..." option

Now Google shows you a link like this:

https://docs.google.com/spreadsheets/d/1s_p1gcL2BBO_zYIe_v8bADjWzFtc0hh_eY8DIw8OPfY/edit?usp=sharing

The ID of the sheet is the bold part, copy it and paste it in a nanDECK line like this:

`LINK=1s_plgcL2BBO_zYIe_v8bADjWzFtc0hh_eY8DIw8OPfY`

You can also select one of the sheets, with this syntax:

`LINK=ID!Sheet_name`

Example:

`LINK=1s_plgcL2BBO_zYIe_v8bADjWzFtc0hh_eY8DIw8OPfY!Beta`

But you must enable the web sharing, with these steps:

- open the spreadsheet in a browser
- select from menu File → Publish to the Web
- click on “Publish” button

LINKADO

If you enable this option, the ADO libraries (ActiveX Data Objects) are used to open spreadsheet files (instead of the internal library). This option can be useful when files are open concurrently in other programs.

Syntax:

`LINKADO = switch`

Parameter:

switch: values accepted are:

ON uses the ADO libraries
OFF uses the internal libraries (the default)

LINKAUTO

If you enable this option, when a linked file is saved the related script is automatically validated and built.

Syntax:

`LINKAUTO = switch`

Parameter:

switch: values accepted are:

ON to enable the automatic build
OFF to disable the automatic build (the default)

LINKCACHE

If you enable this option, a Google linked sheet is saved to disk after the download to speed up subsequent executions.

Syntax:

`LINKCACHE = switch`

Parameter:

switch: values accepted are:

ON the Google sheet is saved to disk

OFF the Google sheet is always downloaded (the default)

LINKCOLOR

This directive is used to create a sequence with the colors or font information from spreadsheet's cells; it must be used before the LINK directive (see page 144).

Syntax:

LINKCOLOR = label, "field", *flag*

Parameters:

label: is the name of the sequence

"field": is the name of the field from the spreadsheet

flag: it specifies if the color read is from the background or the font, if not specified is read from the background:

F	font color
B	background color
N	font name
S	font size

LINKCSV

This directive modifies the encoding of csv file read with a LINK directive (see page 144). If not used, the default is ANSI encoding.

Syntax:

LINKCSV = encoding

Parameter:

encoding: values accepted are:

- ANSI
- UTF7
- UTF8
- UTF16
- UTF16BE

Example:

```
LINKCSV = UTF8  
LINK = data.csv
```

LINKENCCSV

This directive is used to specify which characters are replaced with `\n` encoding (where **n** is the ASCII code) when read from a csv file with the LINK directive (see page 144). As default, there are not characters encoded.

Syntax:

LINKENCCSV = *string*

LINKENCODE

This directive is used to specify which characters are replaced with `\n` encoding (where **n** is the ASCII code) when read from a spreadsheet file with the LINK directive (see page 144). As default, characters encoded are [] { }.

Syntax:

LINKENCODE = *string*

LINKEXEC

This directive is used to specify that one or more fields in a spreadsheet linked with the LINK directive (see page 144) are used to store commands in nanDECK's scripting language (commands that are executed as they would be read from the current script). Note that if you use directives that are related to others (like FONT/TEXT) they must reside before the LINK line.

Syntax:

LINKEXEC = field1, *field2*, ..., *fieldN*

LINKFILL

This directive is used when you have a schema on several rows in a spreadsheet and you want to straighten it in a single row (using the first line to specify the total number of columns that will be filled with the cells); this directive must be used before the LINK command (see page 144).

Syntax:

LINKFILL = switch, *columns*

Parameter:

switch: values accepted are:

ON to enable the redistribution of the cells
OFF to disable the redistribution of the cells (the default)

columns: when there are empty cells, you can use this parameter to specify the actual number of columns

LINKFILTER

This directive is used to filter the rows in a linked file. You can specify more than one LINKFILTER directive for a linked file and must be used before the LINK directive (see page 144).

Syntax:

LINKFILTER = CLEAR | field operator value

Parameters:

field: is the name of the field for the filter

operator: these are the possible operators used for the filter:

= equal
> major
< minor
>= major or equal
<= minor or equal
<> different
@ contained into
not contained into

value: is the value used for the filter

Example:

Linked file:

```
Name, count
Alpha, 1
Beta, 2
Gamma, 3
```

With this script line:

```
LINKFILTER = count < 3
LINK = linked.csv
```

The resulting linked file will be:

```
Name, count
Alpha, 1
Beta, 2
```

If you want to clear all filter, you can use this directive with “CLEAR” parameter:

```
LINKFILTER = CLEAR
```

LINKFONT

This directive adds a couple of HTML tag when a different font is read from a cell in a linked spreadsheet; this directive must be used before the LINK command (see page 144).

Syntax:

```
LINKFONT = switch
```

Parameter:

switch: values accepted are:

```
ON    to enable the font detection
OFF   to disable the font detection (the default)
```

LINKMULCOPY

This directive enables/disables the copy of identical card when a linked file is preceded by the LINKMULTI directive (see page 150); this directive must be used before the LINK command (see page 144).

Syntax:

```
LINKMULCOPY = switch
```

Parameter:

switch: values accepted are:

```
ON    to enable the copy of identical cards (the default)
OFF   to disable the copy, each card is created from the script, even if it is identical to prior cards
```

LINKMULDIS

When a linked file is used with a LINKMULTI directive (see page 150), you can specify with this directive one or more fields that are not replicated; instead of a replica, a single element in a sequence field is taken for each record. It must be used before the LINK directive (see page 144).

Syntax:

```
LINKMULDIS = “field1”, “field2”, ... “fieldN”
```

For example, if this is a linked file:

```
name, count, data
Alpha, 1, a
Beta, 2, b|c
Gamma, 3, d|e
```

And you add these lines to your script:

```
LINKMULTI = count
LINKMULDIS = data
LINK = linked.csv
```

The resulting linked file will be:

```
name, count, data
Alpha, 1, a
Beta, 2, b
Beta, 2, c
Gamma, 3, d
Gamma, 3, e
Gamma, 3, d
```

Note: if a sequence is smaller than the requested number of replicated rows, it is extended (like the `d|e` sequence in the example, extended to `d|e|d` for the three rows).

Note: if you use the `$` symbol in the linked field, it gives you a count starting from one on each new row multiplied by `LINKMULTI`.

LINKMULTI

This directive is used to specify a field, used for identifying a multiplier for a line in a linked file. It must be used before the `LINK` directive (see page 144) and it must refer an existing field in the linked file (or a field specified in the `LINK` directive). Note that the default behavior is to copy the 1st card over the others, if instead you need that all the cards are created, use a `LINKMULCOPY=OFF` line before the `LINKMULTI` (see page 149). As an alternative to a field, a number can be used directly to indicate that all cards in the spreadsheet must be multiplied by that number.

Syntax:

```
LINKMULTI = field
```

The field parameter must be a column in the spreadsheet and must contain a number or a special syntax that specifies another field to split into multiple segments, with one of these syntaxes:

<code>field/num</code>	splits the contents of the field into segments, each of <i>num</i> characters
<code>field\num</code>	splits the contents of the field into segments, each of <i>num</i> characters, and words are not splitted
<code>field\num\char</code>	splits the contents of the field into segments, each of <i>num</i> characters, and words (strings separated by <i>char</i>) are not splitted

With this special syntax you can also use three counters:

<code>\$</code>	indicates the number of the current segment
<code>\$\$</code>	indicates the total number of segments
<code>\$\$\$</code>	shows these two numbers separated by a slash (note: 1/1 it is not shown)

For example, if this is a linked file:

```
Name, count
Alpha, 1
Beta, 2
```

```
Gamma, 3
```

And you add these lines to your script:

```
LINKMULTI = count  
LINK = linked.csv
```

The resulting linked file will be:

```
Name, count  
Alpha, 1  
Beta, 2  
Beta, 2  
Gamma, 3  
Gamma, 3  
Gamma, 3
```

LINKNEW

This directive is used to specify a string, used in substitution for a carriage return read from a spreadsheet file with the LINK directive (see page 144). If you do not specify a LINKNEW directive in your script file, every carriage return read is replaced by `\13`.

Syntax:

```
LINKNEW = string
```

If you want to use a linked file with an HTMLTEXT directive, you should convert all the carriage returns with the corresponding HTML code, i.e.:

```
LINKNEW = <br>
```

LINKRANDOM

This directive enables/disables the randomization of lines read with a LINK directive (see page 144), it must be used before the LINK line.

Syntax:

```
LINKRANDOM = switch
```

Parameter:

switch: values accepted are:

```
ON      To enable randomization  
OFF     To disable randomization (the default)
```

Example:

```
LINKRANDOM = ON  
LINK = linked.csv
```

LINKREP

This directive is used to replace a string with another when reading data from a LINKed file (see page 144); you can use multiple LINKSEPs before the LINK line. The syntax is:

```
LINKREP = "from", "to"
```

Example

```
LINKREP = "|", &brvbar;
```

LINKSEP

This directive is used to specify the character used in a link file to separate fields. It must be used before the LINK directive (see page 144).

If this command is omitted, is used the default separator, a comma “,”.

Syntax:

```
LINKSEP = separator
```

You can also specify a special character with the syntax `\n`. For example, for a tab you can use this line:

```
LINKSEP = \9\
```

Example:

```
LINKSEP = ;  
LINK = linked.csv
```

LINKSPLIT

This directive is used to read each line from a linked file as two different lines. It must be used before the LINK directive (see page 144).

Syntax:

```
LINKSPLIT = every row, odd rows, even rows
```

The fields specified in the 1st parameter are duplicated in two rows, those specified in the 2nd parameter are put only in the 1st row, and those specified in the 3rd parameter are put only in the 2nd row. Every parameter can contain more than one field, separated by a pipe (“|” symbol).

LINKSTYLES

This directive is used to specify alternatives for HTML tags when reading formats from a spreadsheet file. It must be used before the LINK directive (see page 144).

If this command is omitted, the standard HTML tags are used instead.

Syntax:

```
LINKSTYLES = bold on, bold off, italic on, italic off, strikeout on, strikeout off, underline on, underline off, superscript on, superscript off, subscript on, subscript off
```

LINKTAB

This directive is used to specify a string, used in substitution for a tabulation read from a spreadsheet file with the LINK directive (see page 144). If you do not specify a LINKTAB directive in your script file, every tabulation read is deleted.

Syntax:

```
LINKTAB = string
```

LINKTRIM

This directive enables/disables the deletion of empty rows at the end of a spreadsheet file; this directive must be used before the LINK command (see page 144).

Syntax:

LINKTRIM = switch

Parameter:

switch: values accepted are:

ON to enable the deletion of empty rows (the default)
OFF to disable the deletion of empty rows

LINKUNI

This directive enables/disables the conversion of Unicode characters when read from a spreadsheet file (to be used with an HTMLTEXT directive, see page 127); this directive must be used before the LINK command (see page 144).

Syntax:

LINKUNI = switch

Parameter:

switch: values accepted are:

ON to enable the Unicode conversion (the default)
OFF to disable the Unicode conversion

LOADPDF

This directive draws a page(s) taken from a PDF file into a range of cards. If you want to know how many pages are in the file, use the PDFPAGES function (see page 39).

Syntax:

LOADPDF = “range”, “filename”, pos x, pos y, width, height, *number*, *dpi*, *angle*, *flags*

Parameters:

“range”: a set of cards

“filename”: name of the PDF file

pos x: horizontal position (in cm)

pos y: vertical position (in cm)

width: width of the text’s rectangle (in cm)

height: height of the text’s rectangle (in cm)

***number*:** the page to be printed, if not specified the default is 1

***dpi*:** the resolution of the image, if not specified the default is 300

***angle*:** angle of PDF rotation, can be 0 for no rotation

***flags*:** one or more of these flags

I the PDF is converted using the internal library (the default)
E the PDF is converted using Ghostscript (the exe path is set in the Gswin32c option in the “Config” button)

Example:

```
LOADPDF = 1-10, "nandeck-manual.pdf", 0, 0, 100%, 100%, {$}
```

LOG

This directive appends a string in a text file, if the file does not exist, it will be created. If you do not specify a string, the file is deleted instead.

Syntax:

```
LOG = "range", "filename", "string"
```

Parameters:

"range": a set of cards

"filename": name of the file (if is empty, it is written to the log windows)

"string": the string that will be written in the text file (if you specify "nandeck.log", it is written the content of the log windows)

Example:

```
LOG = 1-10, "log.txt", "Card n° {$}"
```

MACRO

With this directive, you can create new procedures, to be used like other directives. The END directive marks the end of the new procedure, and you can specify a list of parameters, delimited with parenthesis, to be reused in the script block. You can also specify a default value for each parameter, then if you did not use a parameter when you call a macro, the default value is used instead. In a macro, you can recall another macro, but you cannot create recursive macros.

Syntax:

```
MACRO = name, (parameter1)value1, (parameter2)value2, ...
```

```
...  
END
```

Example:

```
[black] = #000000  
[red] = #FF0000  
[blue] = #0000FF  
;  
MACRO = dot, (rng), (x), (y), (r)  
  ELLIPSE = (rng), (x)-(r), (y)-(r), (r)*2, (r)*2, [red][blue]@0  
END  
;  
MACRO = shadow, (rng), (x), (y), (w), (h), (txt), (col)  
  FONTRANGE = (rng), Arial, 20, B, [black]  
  TEXT = (rng), "txt", (x)+0.08, (y)+0.08, (w), (h), CENTER, CENTER, 0, 50  
  FONTRANGE = (rng), Arial, 20, BT, (col)  
  TEXT = (rng), "txt", (x), (y), (w), (h), CENTER  
END  
;  
MACRO = card, (rng), (txt), (x), (y), (w), (h), (col)  
  shadow = (rng), (x), (y), (w), (h), (txt), (col)  
  dot = (rng), (x), (y), 0.5  
  dot = (rng), (x)+(w), (y), 0.5  
  dot = (rng), (x), (y)+(h), 0.5  
  dot = (rng), (x)+(w), (y)+(h), 0.5  
END  
;
```

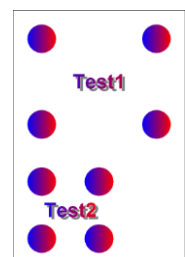

Figure 43

```
card = 1, "Test1", 1, 1, 4, 3, [red][blue]@0
card = 1, "Test2", 1, 6, 2, 2, [red][blue]@0
Result: Figure 43
```

MANDALA

This directive draws a random image in a rectangle in a set of cards.

Syntax:

MANDALA = "range", pos x, pos y, width, height, *glyphs*, *angles*, *segments*, *min width*, *max width*, *min length*, *max length*, *color*, *red*, *green*, *blue*

Parameters:

"range": a set of cards

pos x: horizontal position (in cm)

pos y: vertical position (in cm)

width: width of the rectangle (in cm)

height: height of the rectangle (in cm)

glyphs: the number of images created and superimposed (default 8)

angles: the max number of radial symmetries (default 16)

segments: the number of connected segments (default 32)

min width: the starting width of a segment (in cm)

max width: the ending width of a segment (in cm)

min length: the random minimum length of a segment (in cm)

max length: the random maximum length of a segment (in cm)

color: one or more color to be used in the image (if not specified, a random color is used)

red: variability of red component in subsequent colors (from 0 to 255)

green: variability of green component in subsequent colors (from 0 to 255)

blue: variability of blue component in subsequent colors (from 0 to 255)

Example:

```
MANDALA = 1, 0, 0, 6, 9
Result: Figure 45
```

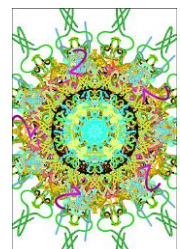

Figure 44

MARGINS

This directive sets the page's margins. If the directive MARGINS is not specified, the standard margins are 1 cm (each).

Syntax:

MARGINS = left margin, right margin, top margin, bottom margin, *odd horiz*, *odd vert.*, *even horiz.*, *even vert.*

Parameters:

left margin: left margin (in cm)

right margin: right margin (in cm)

top margin: top margin (in cm)

bottom margin: bottom margin (in cm)

odd horiz.: horizontal margins offset in odd pages (in cm)

odd vert.: vertical margins offset in odd pages (in cm)

even horiz.: horizontal margins offset in even pages (in cm)

even vert.: vertical margins offset in even pages (in cm)

Example:

```
MARGINS = 2, 2, 1, 1
```

MERGEPDF

This directive creates a new PDF file, you can specify a file or a sequence of files as sources, with related page ranges (the syntax for a range is, for example, "1-10,15,18,20-30"); if the result file is not already present, it is created (otherwise, it is overwritten).

Syntax:

```
MERGEPDF = "result file", "source file", "source range", rotation
```

Parameters:

“**result file**”: the file that is created

“**source file**”: a file or a sequence of files taken as the source of the resulting file

“**source range**”: a range or a sequence of ranges

rotation: an angle or a sequence of angles (only 0, 90, 180, or 270 are accepted)

Note: PDF creation is done in a separate thread, so it is best to wait a few seconds after execution ends to open the PDF (to be sure that writing is complete).

Example:

```
MERGEPDF = "result.pdf", "source1.pdf|source2.pdf", 1-10|11-20
```

MODULEPDF

This directive reads an existing PDF and adds an editable field. In addition to the parameters indicated, you can use the FONT directive (see page 113) to specify the name, size, and color of the text font, and the background color of the field; if the result file is not already present, it is created (otherwise, it is overwritten).

Syntax:

```
MODULEPDF = "result file", "source file", page, pos x, pos y, width, height, "default ", alignment, multiline, transparent
```

Parameters:

“**result file**”: the PDF file that is created

“source file”: the source PDF file

page: the page where the field is inserted

pos x: horizontal position (in cm) in the page

pos y: vertical position (in cm) in the page

width: width of the field (in cm)

height: height of the field (in cm)

“default”: the text written in the field (you can leave it blank)

alignment: the alignment of the text in the field, can be LEFT (the default), CENTER, or RIGHT

multiline: you can indicate ON or OFF (the default), if ON the field can contain multiple lines of text

transparent: you can indicate ON or OFF (the default), if ON the field background is transparent

Note: PDF creation is done in a separate thread, so it is best to wait a few seconds after execution ends to open the PDF (to be sure that writing is complete).

Example:

```
FONT = Arial, 12, , #FF0000, #00FF00  
MODULEPDF = "result.pdf", "source.pdf", 1, 1, 1, 10, 2
```

MOSAIC

This directive reads all the images in a folder and arrange them in a rectangle. If the images fill more than one instance of that rectangle, you can use a **page** parameter to specify which rectangle is drawn from all the possible choices.

Syntax:

MOSAIC = “range”, “folder”, pos x, pos y, width, height, *page, flags, zoom*

Parameters:

“range”: a set of cards

“folder”: a folder to search, eventually with a file pattern

pos x: horizontal position (in cm)

pos y: vertical position (in cm)

width: width of the rectangle (in cm)

height: height of the rectangle (in cm)

page: if not specified, is equal to **1**

flags: one or more of these flags

H the schema is mirrored horizontally
V the schema is mirrored vertically
S the images are read also in the subfolders

zoom: if not specified, is equal to **100**

Example:

```
MOSAIC = 1, "images\*.png", 0, 0, 0, 100%
```

NANDECK

This directive executes another instance of the program, loads a script, render all the cards, and saves them to disk. Then the execution continues with the next line. This directive is executed only one time with each run of the script. If you add an asterisk (*) to the beginning of the script name, the program does not wait for the script to complete.

Syntax:

```
NANDECK = "source", output, "path", dpi, oversample, "range"
```

Parameters:

“source”: another nanDECK script

output: this flag specifies the format of the saved images; you can choose between:

BMP
JPG
PNG
GIF
GIFA
TIF
PDF

“path”: the path for the saved images, if is not specified, the images are saved in the save folder of the source

dpi: the resolution for the images (see page 65), the default is 300

oversample: the value for the oversample (see page 159), the default is 1 (no oversample)

“range”: you can specify a range if you do not want to render all the deck

Example:

```
NANDECK = "c:\scripts\test.txt", PNG, "c:\output"
```

NEXT

This directive closes a FOR...NEXT loop (see page 116).

Syntax:

```
NEXT
```

Parameters:

none

ORIGIN

With this directive you can specify values to be added to the horizontal and vertical coordinates of all graphic directives in a range of cards. If you use percentages for size, you can use the 3rd and 4th parameters to specify what % is the size of a card, or the 5th and 6th parameters to specify what size is 100%.

Syntax:

```
ORIGIN = range, pos x, pos y, hor. perc., ver. perc., width., height
```

Parameters:

“range”: a set of cards

pos x: the offset value for all horizontal coordinates

pos y: the offset value for all vertical coordinates

hor. perc.: this value is the % of the width of a card (the default is 100)

ver. perc.: this value is the % of the height of a card (the default is 100)

width: this value is the size of the card equal to a width of 100%

height: this value is the size of the card equal to a height of 100%

Example:

```
ORIGIN = 1-10, 0.5, 0.5
```

OVERSAMPLE

If you specify a parameter greater than one, the program works with cards 2x, 3x, or greater than the size specified, and then resize them to the original size, using the filter specified with IMAGEFILTER directive (see page 135). It is useful to smooth every element of the cards, especially with small size one.

Syntax:

OVERSAMPLE = number

Example:

```
OVERSAMPLE = 2
```

With this directive, the memory required (and the rendering time) is much more than usual.

PAGE

This directive sets the paper' size and orientation (for printing and PDF creation).

Syntax:

PAGE = width, height, orientation, *flags*, *html color*, “no border range”, *edge color*, *edge left*, *edge right*, *edge top*, *edge bottom*

Parameters:

width: page width (in cm)

height: page height (in cm)

orientation: the orientation can be chosen between:

LANDSCAPE horizontal
PORTRAIT vertical

flags: in this parameter, you can specify a special behavior for pages, possible values are:

H the cards are horizontally centered
V the cards are vertically centered

E guides are not printed on even pages
O guides are not printed on odd pages
M the horizontal margins are mirrored in even pages
D the page is centered (with H/V flags) without considering the edges
L guides are not printed in the left half of the page
R guides are not printed in the right half of the page
T guides are not printed in the top half of the page
B guides are not printed in the bottom half of the page
U the page edges are drawn over the guidelines

html color: paper color, in the same format used for HTML; you can also use a sequence of two or more colors, if you want a different color on each page

no border range: if a range is specified, the border is not printed on these cards

edge color: edge color, in the same format used for HTML; you can also use a sequence of two or more colors if you want a different color on each page.

edge left: the horizontal width of a colored area at the left edge of the page

edge right: the horizontal width of a colored area at the right edge of the page

edge top: the vertical height of a colored area at the top edge of the page

edge bottom: the vertical height of a colored area at the bottom edge of the page.

If the directive PAGE is not specified, the standard is 21 x 29.7 (A4), portrait, no flags

Example:

```
PAGE = 21, 29.7, LANDSCAPE
```

PAGEBREAK

This directive indicates a sequence whose values are associated with the cards. Every time the corresponding value changes between one card and another, a page break is added to the printout.

Syntax:

```
PAGEBREAK = "values"
```

Example:

```
PAGEBREAK = [element]
```

PAGEFONT

This directive changes the font's characteristics for page's headers (see page 120), footers (see page 116) and text (see page 162). If you do not specify this directive in your script, it will be used Arial 10, black.

Syntax:

```
PAGEFONT = "font name", font size, style, html color
```

Parameters:

"font name": character's name (string)

font size: character's size (integer), in typographical points = 1/72 of an inch

style: character' style, values accepted are:

B bold
I italic
U underline
S strikeout

html color: character's color, in the same format used for HTML

Examples:

```
PAGEFONT = Arial, 10, B, #000000
```

```
PAGEFONT = "Times new roman", 16, IU, #FF0000
```

PAGEIMAGE

This directive draws an image centered on all the printed pages (like a watermark).

Syntax:

```
PAGEIMAGE = "image file", flags
```

Parameters:

"image file": the image to be printed

***flag*:** one or more of the following flags:

P proportional
E do not print on even pages
O do not print on odd pages

Example:

```
PAGEIMAGE = watermark.png, P
```

<i>Note: use only .bmp or .png images</i>

PAGESHAPE

This directive draws lines, rectangles, and ellipses directly in a page (therefore there is not a range parameter, and a 100% here refers to the whole page, not to the card).

Syntax:

```
PAGESHAPE = pos x, pos y, width, height, flags, html color
```

Parameters:

pos x: horizontal position (in cm)

pos y: vertical position (in cm)

width: width of the shape (in cm)

height: height of the shape (in cm)

flags: one or more of the following flags:

A draw a rectangle
I draw an ellipse
S set solid background

M	set empty background
0	set solid edge
1	set dotted edge
2	set dashed edge
3	set dash+dot pattern for edge
4	set dash+dot+dot pattern for edge
T	draw a line in the top side of the rectangle
R	draw a line in the right side of the rectangle
B	draw a line in the bottom side of the rectangle
L	draw a line in the left side of the rectangle
H	draw a horizontal line in the middle of the rectangle
V	draw a vertical line in the middle of the rectangle
D	draw a diagonal line in the rectangle
G	draw a diagonal line (reversed) in the rectangle
E	do not draw the shape on even pages
O	do not draw the shape on odd pages

html color: color of the shape, in the same format used for HTML

Example:

```
PAGESHAPE = 1, 1, 19, 27.7, MA, #0000FF
PAGESHAPE = 0.25, 0.25, 0.5, 0.5, SI, #FF0000
PAGESHAPE = 20.25, 0.25, 0.5, 0.5, SI, #FF0000
PAGESHAPE = 0.25, 28.95, 0.5, 0.5, SI, #FF0000
PAGESHAPE = 20.25, 28.95, 0.5, 0.5, SI, #FF0000
```

PAGETEXT

This directive writes a text directly in a page (therefore there is not a range parameter, and a 100% here refers to the whole page, not to the card). The font can be specified with a PAGEFONT directive (see page 160).

Syntax:

PAGETEXT = pos x, pos y, width, height, flags, text, *angle*

Parameters:

pos x: horizontal position (in cm)

pos y: vertical position (in cm)

width: width of the text area (in cm)

height: height of the text area (in cm)

flags: one or more of the following flags:

E	do not write the text on even pages
O	do not write the text on odd pages

text: the text written in the page

angle: angle of text rotation, if not specified it is assumed to be 0 (for no rotation)

Example:

```
PAGETEXT = 0, 0, 6, 1, , "Version 1.0"
```

PATTERN

This directive prints repeated images in a rectangular area. If you want to print different images instead, you can use the ICONS directive (see page 129).

Syntax:

PATTERN = "range", "image file", repetition, pos x, pos y, width, height, obj width, obj height, *angle, flags, horizontal alignment, vertical alignment, alpha*

Parameters:

"range": a set of cards

"image file": an existent image file (eventually with a path), formats allowed are bmp, gif, png, jpg, and tif

repetition: the number of images printed (you can also use a sequence here)

pos x: horizontal position (in cm)

pos y: vertical position (in cm)

width: width of the rectangle in which the images are printed (in cm)

height: height of the rectangle in which the images are printed (in cm)

obj width: width of the single image to be printed (in cm)

obj height: height of the single image to be printed (in cm)

angle: angle of image rotation, if not specified it is assumed to be 0 (for no rotation)

flags: in this parameter, you can specify a special behavior for images, possible values are:

T	Transparent
A	Anti-aliasing
R	Reverse, reversing the filling order of pattern's elements (from bottom to top)
N	Use PNG transparency
P	Proportional
V	Vertical pattern

horizontal alignment: the images' horizontal alignment in the rectangle, values accepted are:

LEFT	left aligned
CENTER	centered (the default)
RIGHT	right aligned

vertical alignment: the images' vertical alignment in the rectangle, values accepted are:

TOP	top aligned
CENTER	centered (the default)
BOTTOM	bottom aligned

alpha: level of transparency of text, from 0 (full transparent) to 100 (full solid). If omitted, the level is set to 100 (full solid). You can also specify an angle for the transparency, with the format **level@angle**; in this case, the level of transparency is the starting level, ending with 0 (full transparent)

Example:

```
[img] = "c:\images\dot_red.gif"
RECTANGLE = 1, 0, 0, 6, 5, #0000FF
PATTERN = 1, [img], 5, 0, 1, 6, 3, 1.5, 1.5, 0, T, CENTER, CENTER
```

Result: Figure 45

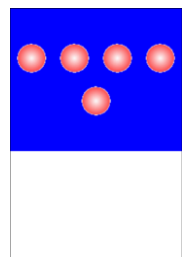

Figure 45

PIE

This directive draws a pie slice in a set of cards.

Syntax:

PIE = “range”, pos x, pos y, width, height, start angle, end angle, html color, *html color*, *thickness*

Parameters:

“range”: a set of cards

pos x: horizontal position (in cm)

pos y: vertical position (in cm)

width: width of the pie (in cm)

height: height of the pie (in cm)

start angle: start angle of pie (0=north, 90=east, 180=south, 270=west)

end angle: end angle of pie (0=north, 90=east, 180=south, 270=west)

html color: border color of the pie, in the same format used for HTML, you can also specify a gradient

html color: inner color of the pie, in the same format used for HTML, if not specified the inner color is the same of border color. You can also specify “EMPTY” for a hollow pie or a gradient

thickness: thickness of the border of the pie (in cm), if omitted, the pie’s border is 1 pixel wide

Examples:

```
PIE = 1, 1, 3, 4, 4, 0, 90, #00FF00
```

Result: Figure 46

```
PIE = 1, 1, 3, 4, 4, 90, 270, #FF00FF, EMPTY, 0.1
```

Result: Figure 47

```
PIE = 1, 1, 3, 4, 4, 0, 270, #FF0000#0000FF@90
```

Result: Figure 48

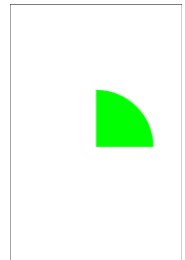

Figure 46

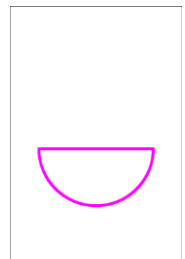

Figure 47

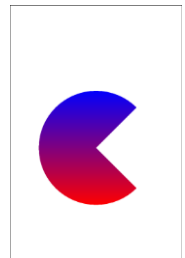

Figure 48

PNGCOMP

This directive sets the compression level for png images saved with a SAVE directive (see page 171).

Syntax:

PNGCOMP = “range”, compression, *filter*

Parameters:

“range”: a set of cards

compression: the level of compression, from 0 (none) to 9 (maximum)

filter: the method used to evaluate the difference when applying compression; can be chosen from:

NONE

SUB

UP

AVERAGE

PAETH

POLY

This directive stores a point on a path that will become an irregular polygon; the polygon will be closed and drawn when you also specify a color.

Syntax:

POLY = “range”, pos x, pos y, *html color*, *html color*, *thickness*

Parameters:

“range”: a set of cards

pos x: horizontal position of the point (in cm)

pos y: vertical position of the point (in cm)

html color: border color of the polygon, in the same format used for HTML, you can also specify a gradient

html color: inner color of the polygon, in the same format used for HTML, if not specified the inner color is the same of border color. You can also specify “EMPTY” for a hollow polygon or a gradient

thickness: thickness of the border of the polygon (in cm), if omitted, the polygon’s border is 1 pixel wide

Example:

```
POLY = 1, 1, 1
POLY = 1, 5, 1
POLY = 1, 4, 4.5
POLY = 1, 5, 8
POLY = 1, 1, 8
POLY = 1, 2, 4.5, #404040#D0D0D0#404040@0, #0000FF#00FFFF@90, 0.3
```

POLYGON

This directive draws a polygon in a set of cards.

Syntax:

POLYGON = “range”, pos x, pos y, width, height, num sides, angle, *html color*, *html color*, *thickness*, *start side*, *end side*, *zoom*, *factor start*, *factor end*, *radius start*, *radius end*

Parameters:

“range”: a set of cards

pos x: horizontal position (in cm)

pos y: vertical position (in cm)

width: width of the polygon (in cm)

height: height of the polygon (in cm)

num sides: number of sides (3 = triangle, 4 = square, 5 = pentagon, and so on...)

angle: angle of rotation (in degrees)

html color: border color of the polygon, in the same format used for HTML, you can also specify a gradient

html color: inner color of the polygon, in the same format used for HTML, if not specified the inner color is the same of border color. You can also specify “EMPTY” for a hollow polygon or a gradient

thickness: thickness of the border of the polygon (in cm), if omitted, the polygon's border is 1 pixel wide

start side: the polygon is drawn starting from this side; if omitted is equal to 1

end side: the polygon is drawn until this side, if omitted is equal to **num sides**

zoom: if not specified, is equal to **100**

factor start: if specified, each edge is drawn as a bezier curve, using this parameter as the offset factor along the tangent of the start point handle

factor end: if specified, each edge is drawn as a bezier curve, using this parameter as the offset factor along the tangent of the end point handle

radius start: if specified, each edge is drawn as a bezier curve, using this parameter as the offset factor along the radius of the start point handle

radius end: if specified, each edge is drawn as a bezier curve, using this parameter as the offset factor along the radius of the end point handle

Note: If you use curved edges, the interior of the polygon is not filled

Examples:

```
POLYGON = 1, 1, 1, 4, 7, 3, 45, #00FF00
```

Result: Figure 49

```
POLYGON = 1, 1, 1, 4, 7, 4, 0, #FF00FF, EMPTY, 0.1
```

Result: Figure 50

```
POLYGON = 1, 1, 1, 4, 7, 5, 0, #FF0000#0000FF@90
```

Result: Figure 51

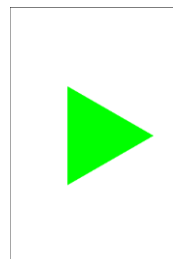

Figure 49

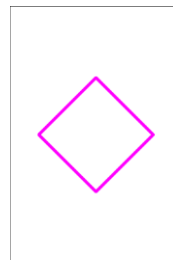

Figure 50

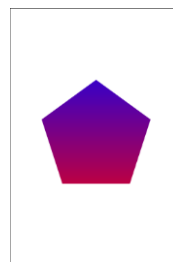

Figure 51

PRINT

This directive restricts the deck creation to the specified cards.

Syntax:

```
PRINT = "range" | DUPLEX | FOLD | COMPARE
```

Parameters:

"range": a range of cards. If you specify the DUPLEX parameter, the range is built using information from the DUPLEX directive (see page 106), if you specify the FOLD parameter, the range is built using information from the FOLD directive (see page 112), if you specify the COMPARE parameter, is used the range created with a COMPARE directive (see page 99).

Examples:

```
PRINT = "1-3, 8, 10-12"
```

```
PRINT = DUPLEX
```

QR CODE

This directive draws a QR Code (useful to be read with a smartphone) in a set of cards.

Syntax:

```
QR CODE = "range", "text", pos x, pos y, width, height, html color, html color
```

Parameters:

“**range**”: a set of cards

“**text**”: the text written in the QR Code

pos x: horizontal position (in cm)

pos y: vertical position (in cm)

width: width of the QR Code (in cm)

height: height of the QR Code (in cm)

html color: color of the QR Code, in the same format used for HTML, black if not specified. You can also specify a gradient

html color: color of the background, in the same format used for HTML, white if not specified. You can also specify a gradient

Example:

```
QRCODE = "1-10", "http://www.nandeck.com", 1, 1, 4, 4
```

RANGE

The parameter specifies several cards that is added to all subsequent ranges. This directive is useful to merge two scripts that draws cards in the same range, without having to rewrite all the ranges of the 2nd script.

Syntax:

RANGE = offset

Example:

```
RECTANGLE = 1-2, 0, 0, 100%, 100%, #FF0000  
RANGE = 2  
RECTANGLE = 1-2, 0, 0, 100%, 100%, #0000FF
```

RECTANGLE

This directive draws a rectangle in a set of cards.

Syntax:

RECTANGLE = “range”, pos x, pos y, width, height, html color, *html color*, *thickness*

Parameters:

“**range**”: a set of cards

pos x: horizontal position (in cm)

pos y: vertical position (in cm)

width: width of the rectangle (in cm)

height: height of the rectangle (in cm)

html color: border color of the rectangle, in the same format used for HTML, you can also specify a gradient

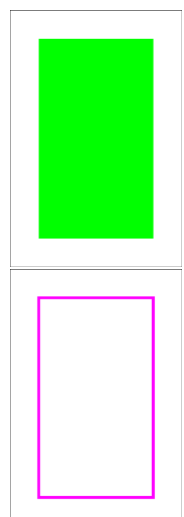

html color: inner color of the rectangle, in the same format used for HTML, if not specified the inner color is the same of border color. You can also specify "EMPTY" for a hollow rectangle or a gradient

thickness: thickness of the border of the rectangle (in cm), if omitted, the rectangle's border is 1 pixel wide

Examples:

```
RECTANGLE = 1, 1, 1, 4, 7, #00FF00
```

Result: Figure 52

```
RECTANGLE = 1, 1, 1, 4, 7, #FF00FF, EMPTY, 0.1
```

Result: Figure 53

```
RECTANGLE = 1, 1, 1, 4, 7, #FF0000#0000FF@90
```

Result: Figure 54

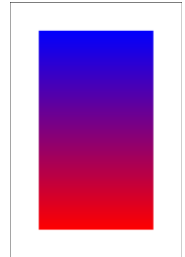

Figure 54

RENDER

With this directive, the program renders only a range of cards (from 1st to 2nd parameter or using a range in the 4th parameter). If omitted, all the deck is rendered. If a **name** is specified, the range is associated with this string, and can be selected on a window, for a faster switch on multiple ranges.

Syntax:

RENDER = first card, last card, *name*, *range*

Examples:

```
RENDER = 10, 20
```

```
RENDER = 1, 10, "full deck"
```

```
RENDER = 1, 5, "first half"
```

```
RENDER = 6, 10, "second half"
```

RHOMBUS

This directive draws a rhombus in a set of cards.

Syntax:

RHOMBUS = "range", pos x, pos y, width, height, html color, *html color*, *thickness*

Parameters:

"range": a set of cards

pos x: horizontal position (in cm)

pos y: vertical position (in cm)

width: width of the rhombus (in cm)

height: height of the rhombus (in cm)

html color: border color of the rhombus, in the same format used for HTML, you can also specify a gradient

html color: inner color of the rhombus, in the same format used for HTML, if not specified the inner color is the same of border color. You can also specify "EMPTY" for a hollow rhombus or a gradient

thickness: thickness of the border of the rhombus (in cm), if omitted, the rectangle's border is 1 pixel wide

Examples:

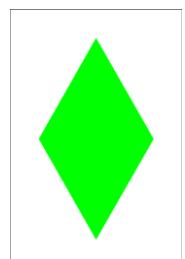

Figure 55

RHOMBUS = 1, 1, 1, 4, 7, #00FF00

Result: Figure 55

ROUNDRECT

This directive draws a rounded rectangle in a set of cards.

Syntax:

RECTANGLE = “range”, pos x, pos y, width, height, html color, *html color*, *thickness*, *round width*, *round height*, *flags*

Parameters:

“range”: a set of cards

pos x: horizontal position (in cm)

pos y: vertical position (in cm)

width: width of the rounded rectangle (in cm)

height: height of the rounded rectangle (in cm)

html color: border color of the rounded rectangle, in the same format used for HTML, you can also specify a gradient

html color: inner color of the rounded rectangle, in the same format used for HTML, if not specified the inner color is the same of border color. You can also specify “EMPTY” for a hollow rounded rectangle or a gradient

thickness: thickness of the border of the rounded rectangle (in cm), if omitted, the rectangle’s border is 1 pixel wide

round width: rounding horizontal factor for the rectangle (1 for a circle), if omitted the default is 5

round height: rounding vertical factor for the rectangle (1 for a circle), if omitted the default is equal to *horizontal factor* parameter (or 5 if the latter is missing)

flags: you can specify one or more flags, chosen between:

F The corners are calculated as specified in the prior two parameters (the default)

R The last two parameters are the radius (horizontal and vertical) of the corners’ ellipses

Note that if you want rounded corners with the same aspect, the horizontal/vertical factors must have a ratio proportional to the width/height of the rectangle.

Examples:

ROUNDRECT = 1, 1, 1, 4, 7, #00FF00

Result: Figure 56

ROUNDRECT = 1, 1, 1, 4, 7, #FF00FF, EMPTY, 0.1, 2

Result: Figure 57

ROUNDRECT = 1, 1, 1, 4, 7, #FF0000#0000FF@90

Result: Figure 58

RTFFILE

This directive prints the RTF text loaded from a filename in the cards specified by a range. This directive is useful if you want to print a text from a document written using a word-processor (every program has the option to save a file in RTF format).

Syntax:

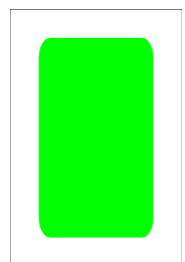

Figure 56

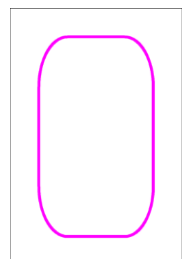

Figure 58

RTFFILE = “range”, “rtf file”, pos x, pos y, width, height, *html color* , *angle*, *flags*, *alpha*

Parameters:

“**range**”: a set of cards

“**rtf file**”: the RTF filename for text to be printed (eventually with a pathname)

pos x: horizontal position (in cm)

pos y: vertical position (in cm)

width: width of the text’s rectangle (in cm)

height: height of the text’s rectangle (in cm)

html color: background color for text

angle: angle of text rotation, you must specify 0 for no rotation

flags: you can specify one or more flags, chosen between:

T	Transparent background for text
H	Horizontal mirror
V	Vertical mirror

alpha: level of transparency of text, from 0 (full transparent) to 100 (full solid). If omitted, the level is set to 100 (full solid). You can also specify an angle for the transparency, with the format **level@angle**; in this case, the level of transparency is the starting level, ending with 0 (full transparent).

Example:

```
RTFFILE = 1, "c:\temp\document.rtf", 0, 0, 6, 8, #FFFF80, 0
```

Result: Figure 59

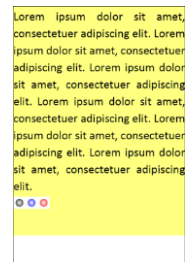

Figure 59

RTFTEXT

This directive prints a text, using RTF format, in the cards specified by a range. This directive is useful if you want to print a text with multiple size, font, attributes, colors and so on. For expression, you must include them in double curly parentheses {{ ... }}.

Syntax:

RTFTEXT = “range”, “text”, pos x, pos y, width, height, *html color* , *angle*, *flags*, *alpha*

Parameters:

“**range**”: a set of cards

“**text**”: the RTF text to be printed

pos x: horizontal position (in cm)

pos y: vertical position (in cm)

width: width of the text’s rectangle (in cm)

height: height of the text’s rectangle (in cm)

html color: background color for text

angle: angle of text rotation, you must specify 0 for no rotation

flags: you can specify one or more flags, chosen between:

T Transparent background for text
H Horizontal mirror
V Vertical mirror

alpha: level of transparency of text, from 0 (full transparent) to 100 (full solid). If omitted, the level is set to 100 (full solid). You can also specify an angle for the transparency, with the format **level@angle**; in this case, the level of transparency is the starting level, ending with 0 (full transparent).

Example:

```
RTFTEXT = 1, "{\rtf normal\par{\b bold}\par{\i italic}\par{\ul underline}}", 0, 0, 6, 6, #FFFF80, 0
```

Result: Figure 60

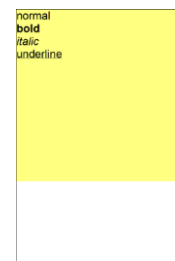

Figure 60

SAVE

This directive saves the full or partial image(s) of card(s) specified by a range in a file(s). You can use expressions like `{§}` to specify different filenames for different cards in the range. The image can also be loaded in another card with IMAGE directive (see page 132). The formats you can use for the image are BMP, JPG, PNG, and GIF, if you did not specify an extension for the filename, the default is BMP. If you did not specify a size, the default is all the cards.

Syntax:

SAVE = “range”, “image file”, *pos x*, *pos y*, *width*, *height*, *transparent color*, “zipfile”, “mask file”, *width pixels*, *height pixels*, *bitplanes*, *flags*, *level*

Parameters:

“range”: a set of cards

“filename”: the name of the file created

pos x: horizontal start of saved area (in cm)

pos y: vertical start of saved area (in cm)

width: width of the saved area (in cm)

height: height of the saved area (in cm)

transparent color: for PNG and GIF, if this parameter is specified, the file is saved with this color as transparent, for PNG files you can also specify more than one color (for example #0000FF#00FF00 for two colors) and add a level of transparency, in the format #xyyyyyyy, where xx = transparency level (from 00 = full transparent to FF = full solid) and yyyyyy = color. Another format accepted is #xyyyyyyyzzz, where zzz is a number that is used as “likeness” of the color to be treated as transparent. Finally, you can also specify a G at the end to proportionally adjust the level of transparency to the level of likeness.

“zipfile”: if this parameter is specified, the image file is added to this zip file

“mask file”: if this parameter is specified (a PNG image), is used as transparency mask for the saved image (note that in this case the “transparent color” is not used)

width pixels: the width of the saved images, in pixels

height pixels: the height of the saved images, in pixels

bitplanes: sets the depth of the saved image, and can be set equal to:

24 16 million of colors (the default)
 16 65536 colors
 8 256 colors
 4 16 colors

flags: you can specify one or more flags, chosen between:

A use an alternate library for saving images in jpeg format
 F the file is deleted at the end of the build phase (useful for temporary files)
 S the rectangle is shrunk until pixels with a different color than the one in the upper left corner are found, then the image is saved enlarged to the size *width x height*
 K the rectangle is shrunk until pixels with a different color than the one in the upper left corner are found, then the image is saved at the found size
 R the image is rotated 90°
 T the image is rotated 180°
 L the image is rotated 270°

level: this parameter is used with S flag, and specifies the difference from the color of the upper left corner and the color that defines the rectangle (if not specified it is considered zero, i.e., the colors must be the same)

Examples:

```
SAVE = 1-3, "card{$}.bmp", 0, 0, 6, 9

RECTANGLE = 1, 1, 1, 4, 7, #0000FF#FF0000@90
RECTANGLE = 1, 0, 0, 6, 9, #000000, EMPTY, 0.5
SAVE = 1, "temp.bmp", 0, 0, 6, 9
IMAGE = 1, "temp.bmp", 3, 0, 3, 4.5, 0, A
```

Result: Figure 61

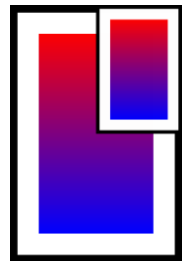

Figure 61

SAVEGIFA

This directive saves the full deck of cards in an animated GIF file specified in “filename” parameter. Note that you can use only one of this kind of directives in a script (only the last is considered).

Syntax:

SAVEGIFA = “filename”, *msec*, *flags*, *transparent color*

Parameters:

“**filename**”: the name of the file to be created (.gif extension)

msec: the delay between each frame (the default is 1000 = 1 second)

flags: one or more of the following flags

O all the images use a single-color palette
 P the color palette(s) are packed
 T the frames of the image are saved with a transparent color, specified in the 4th parameter

transparent color: the transparent color in HTML format (if not specified, is set to white) to be used with the T flag

Example:

```
SAVEGIFA = deck.gif
```

Note: there is not a “range” parameter because only the final deck can be printed (and then exported in an animated GIF file). If you want a partial deck, use a PRINT directive.

SAVEPAGES

This directive saves the full deck of cards in one or more image files (one for each page), with names specified in “filename” parameter, adding a progressive number for each page. The file formats accepted are BMP, JPG (or JPEG), and PNG.

Syntax:

SAVEPAGE = “filename”, *switch*, *color profile*

Parameters:

“**filename**”: the name of the file(s) to be created

The *switch* parameter can optionally be set equal to:

ON to use the CMYK color space when a JPG/JPEG file format is specified
OFF to use the RGB color space (default)

If the former switch is ON, it can also be specified an optional *color profile* parameter, that can be an ICC/ICM file, or a JPG/JPEG (from which a color profile is extracted).

Example:

```
SAVEPAGES = page.png
```

Note: there is not a “range” parameter because only the final deck can be printed (and then exported in one or more image files). If you want a partial deck, use a PRINT directive.

SAVEPDF

This directive saves the full deck of cards in a PDF file specified in “filename” parameter. If you specify a filename with a question mark (?) as a first character, the program asks you if the existing file must be overwritten.

Syntax:

SAVEPDF = “pdf file”, *flags*, *icc profile*

Parameters:

“**pdf file**”: the name of the file to be created (.pdf extension)

flags: one or more of the following flags

A save the file in the PDF/A format
J compress the images as Jpeg
S scale down the images
N do not use compression
L use low level of compression
D use default level of compression
M use max level of compression
C use Ghostscript (exe path in Config) to convert to CMYK color profile

icc profile: use an external file as an ICC profile for CMYK conversion

Example:

```
SAVEPDF = deck.pdf
```

Note: there is not a “range” parameter because only the final deck can be printed (and then exported in a PDF file). If you want a partial deck, use a PRINT directive.

SECTION

Syntax:

SECTION = "text", switch, *flag*

The parameter "text" identify the directives contained between SECTION and ENDSECTION directives, which can then be activated or deactivated (using the **switch** parameter) during build. This allows for self-contained, independent sections of the script, that will only build if their switch parameter is ON.

When you are using SECTIONs and build your deck for the first time a window will pop up for faster activation/deactivation. You may wish to keep this window open for convenience. In this window, there are three buttons: one for enabling all the sections, one for disabling all the sections, and one (named "Cycle build") that validates and builds in sequence all the sections (enabling only one at each cycle). You may also turn on/off any individual section in this window; this switches their SWITCH parameter accordingly. Finally, if you click on the name of each section in this window you will be taken to SECTION line in the script, if you double click you will be taken to ENDSECTION line.

Bear in mind the sections, once defined, have the potential to be completely independent; they are effectively like multiple scripts combined. If two cards of the same range are being written on by different sections and you "Cycle Build" (which builds each section in turn) the latter will completely overwrite the former, which is destroyed; however, if all sections are enabled and you don't "Cycle Build", they will be processed normally, so that, instead of the latest SECTION overwriting an overlapping card, it will add onto it. Any labels or global information that applies to all sections should be defined before your first SECTION, in what will be a global script common to all sections.

The switch parameter can be set equal to:

ON to enable the section
OFF to disable the section

The flag parameter can be one or more of the following flags:

N this section is not included in the "Cycle build" procedure
O when this section is enabled, all the others are disabled (excluding sections with N flag)

Example:

```
SECTION=Border,OFF
  BORDER=RECTANGLE,#FF0000,5%
ENDSECTION

FONT=arial,16,,#000000

SECTION=A,ON
  TEXT=1,"Hi world",0%,0%,100%,50%
ENDSECTION

SECTION=B,ON
  TEXT=1,"Hi yourself",0%,50%,100%,50%
ENDSECTION
```

SEED

By default, random numbers are generated randomly, but using this directive the sequence of random numbers will be fixed, different depending on the number used as a parameter.

This seed number can be set with this directive, or from Config->Main. Note: If you want to set a different seed number for each card, you can use the SEEDRANGE directive (page 175).

Syntax:

SEED=seed number

Example:

```
SEED=10
```

SEEDRANGE

By default, random numbers are generated randomly, but using this directive the sequence of random numbers will be fixed, different depending on the number used as a parameter.

Note: If you want to set a seed number for the validation step, you can use the SEED directive (page 174), or set the seed number from Config->Main.

Syntax:

```
SEEDRANGE = "range", seed number
```

Example:

```
SEEDRANGE = 1-10, 10
SEEDRANGE = 11-20, 0
```

SELECT

The SELECT...ENDSELECT structure can be used to create sections of code that must be executed only if are verified some conditions. In the default mode, a value is evaluated and only the CASE code with the same value is executed; you can also add an operator to be used for the test evaluation.

Syntax:

```
SELECT = value
...
CASE = value1
...
CASE = value2
...
...
CASEELSE
...
ENDSELECT
```

Parameters:

value: a string, number, label, or expression that can be evaluated

Example:

```
CARDS = 4
[TEST] = 1|2|3|4
SELECT = [TEST]
CASE = 1
    RECTANGLE = 1-4, 0, 0, 100%, 100%, #FF0000
CASE = <4
    ELLIPSE = 1-4, 0, 0, 100%, 100%, #0000FF
CASEELSE
    RHOMBUS = 1-4, 0, 0, 100%, 100%, #00FF00
ENDSELECT
```

SEQUENCE

This directive is used to start a SEQUENCE...ENDSEQUENCE structure, for creating one or more sequences.

Syntax:

```
SEQUENCE = label name
```

Parameters:

label name: the name of the label

Each line in this structure is added to the sequence with the name specified as a parameter.

Example:

```
SEQUENCE = Title
Earth
Moon
Mars
Venus
Jupiter
ENDSEQUENCE
```

There is an alternative syntax, for creating multiple sequences. Each line in this structure must contains the name of the sequence and a value, separated with a pipe | character. For example, this script creates five sequences of two elements each:

```
SEQUENCE =

Title      |Earth
Image      |Earth.jpg
Description |Earth is the third planet from the Sun.
Radius     |6.371
Orbital Period|365

Title      |Moon
Image      |Moon.jpg
Description |The Moon is Earth's only natural satellite.
Radius     |1.737
Orbital Period|26

ENDSEQUENCE
```

That script is equivalent to this:

```
[Title] = Earth|Moon
[Image] = Earth.jpg|Moon.jpg
[Description] = Earth is the third planet from the Sun.| The Moon is Earth's
only natural satellite.
[Radius] = 6.371|1.737
[Orbital Period] = 365|26
```

With this alternative syntax you can use a **MULTI=number** line to duplicate the subsequent lines. Example:

```
SEQUENCE
text|One
multi=2
text|Two
multi=3
text|Three
ENDSEQUENCE
```

SET

This directive sets a label with a value. Note: since the syntax **[label]** is replaced in the validations step, if you want to read a value memorized with a SET directive, you must use the **{label?n}** syntax, where **n** is the index of the sequence (use 1 if it is a single value).

Syntax:

SET = “range”, label name, label value

Parameters:

“range”: a set of cards

label name: the name of the label to be changed (or added, if not exists)

label value: the value of the label

SPECIAL

This directive is used to change the special symbols used for some variables. If you do not want to change a specific symbol, leave empty that parameter.

Syntax:

SPECIAL = char cardnum, *char framenum*, *char framename*, *char newline*

Parameters:

char cardnum: the character used for the number of the current card (default \$)

char framenum: the character used for the number of the current frame (default °)

char framename: the character used for the name of the current frame (default μ)

char newline: the character used to divide a single line of code (default ¶)

Example:

```
SPECIAL = $, ^, ?
```

STAR

This directive draws a star in a set of cards.

Syntax:

STAR = “range”, pos x, pos y, width, height, num points, angle, factor, html color, *html color*, *thickness*, *angle*

Parameters:

“range”: a set of cards

pos x: horizontal position (in cm)

pos y: vertical position (in cm)

width: width of the star (in cm)

height: height of the star (in cm)

num points: number of points

angle: angle of rotation (in degrees)

factor: from 0 (very pointy star) to 100 (polygon)

html color: border color of the star, in the same format used for HTML, you can also specify a gradient

html color: inner color of the star, in the same format used for HTML, if not specified the inner color is the same of border color. You can also specify "EMPTY" for a hollow star or a gradient

thickness: thickness of the border of the star (in cm), if omitted, the star's border is 1 pixel wide

angle: angle of rotation of the inner core (in degrees)

Examples:

```
STAR = 1, 1, 1, 4, 7, 3, 0, 20, #00FF00
```

Result: Figure 62

```
STAR = 1, 1, 1, 4, 7, 5, 0, 50, #FF00FF, EMPTY, 0.1
```

Result: Figure 63

```
STAR = 1, 1, 1, 4, 7, 6, 90, 80, #FF0000#0000FF@90
```

Result: Figure 64

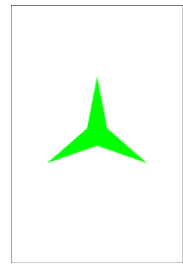

Figure 62



Figure 63

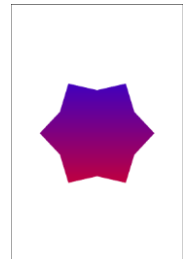

Figure 64

STORE

This directive enables/disables the storing of cards to the deck. The default behavior is that the program memorizes the images of the cards, but it can be disabled, useful when you do not want to print them or create a PDF, but need only the images, to be saved with a SAVE directive (see page 171).

Syntax:

STORE = "range", switch

Parameters:

"range": a range of cards

switch: values accepted are:

ON to enable the storing of cards (the default)

OFF to disable the storing of cards

SYMBOL

This directive draws a NATO symbol in a rectangular area (to be used in a counter for a wargame); the "keys" parameter identifies the symbol used (with a code of three letters), and you can also draw more than one symbol by using a key with two or more codes.

Syntax:

SYMBOL = "range", keys, pos x, pos y, width, height, html color, *html color*, *width*

Parameters:

"range": a set of cards

keys: a string, composed by codes of three characters each

pos x: horizontal position (in cm)

pos y: vertical position (in cm)











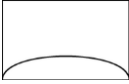

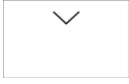





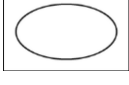

width: width of the rectangle in which the symbols are drawn (in cm)

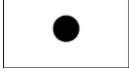
height: height of the rectangle in which the symbols are drawn (in cm)

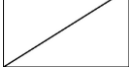
html color: color of the symbol, in the same format used for HTML, you can also specify a gradient

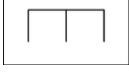
html color: background color of the symbol, in the same format used for HTML, if not specified the background color is not drawn (you can also specify "EMPTY" for the same result)

thickness: thickness of the lines used to draw the symbol (in cm), if omitted, the lines are 1 pixel wide

Code	Description	Symbol	Code	Description	Symbol
ADE	air defense		HQ2	headquarter	
AIM	airmobile		INF	infantry	
AIR	airborne		MAR	marine	
AMP	amphibious		MOT	motorized	
ANT	anti-tank		MTN	mountain	
ARM	armor		PAR	paratrooper	
ART	field artillery		ROC	rocket	
CAV	cavalry		WHE	wheeled	
ENG	engineer		WIF	fixed wing	
HQ1	headquarter		WIR	rotary wing	

Example:

`SYMBOL = 1, INFMTN, 10%, 10%, 80%, 50%, #000000, EMPTY, 2%`

TABLE

This directive opens the virtual table (see page 71) at the end of the building process.

Syntax:

`TABLE = num draw, flags`

Parameters:

num draw: the number of cards drawn when you double click a deck

flags: you can choose these flags:

R	the drawn card is placed at the right of the deck
L	the drawn card is placed at the left of the deck
U	the drawn card is placed at the top of the deck
B	the drawn card is placed at the bottom of the deck
O	the drawn position is rotated
P	the drawn position is randomized
A	enable the alignment to grid
C	show the canvas as a background image
I	the canvas shown as a background image is drawn proportionally
S	automatic selection of object
T	show the tags
F	bring the selected object to the front
M	move complete stacks of cards

TAG

This directive assigns a label and a numeric value to a card (or a range of cards). This tag is shown in the Virtual Table (see page 71) when a card is put in a specific location of the table (if more than one card is in one location, the values of all the tags with the same name are added up).

Syntax:

TAG = “range”, tag, number

Parameters:

“**range**”: a set of cards

tag: the name of the tag

number: the value of the tag (it can be a sequence of values)

Examples:

```
TAG = 1-10, card, 1
```

```
TAG = 1-20, value, 1|2|3|4|5
```

TAGF

This directive creates a filter that is applied in the Simulator: when a card is drawn in a hand, it is kept only if the tag indicated in the first parameter is equal to the number indicated in the second, otherwise it is returned to the deck and another is drawn; this filter is applied to the card indicated in the third parameter.

Syntax:

TAGF = tag, number, card

Parameters

tag: the name of the tag

number: the value of the tag

card: the position of the card in the hand

TAGS

This directive creates a rule that is evaluated in the Simulator. The rule can contain series of letters of numbers, with this syntax:

- one or more “\$” symbol, then letters to define a tag’s value that is present, using the same letter means that the same element is present with that number of copies
 - one or more “£” symbol, then numbers to define the difference between the values of tag when multiple copies are present (i.e., in a straight); with the !N>M syntax is defined that a tag with value N is treated also like M (i.e., the ace in a straight can be positioned before the 2 or after the King)
 - one or more “=” symbol, then one or more tags that must be present in that exact number
 - one or more “+” symbol, then one or more tags that must be present in that number or more
- You can specify more than one rule for a single directive, all of which will be evaluated at the same time, by separating each rule (and each tag) with the pipe character “|”.

Syntax:

TAGS = tag, schema, *name of schema*

Parameters:

tag: the name of the tag used in the schema

schema: letters and numbers that define a rule that is evaluated

name of schema: the name of the schema used in the simulator

Example:

```

TAG = 1-52, value, 1|2|3|4|5|6|7|8|9|10|11|12|13
TAG = 1-13, seed, 1
TAG = 14-26, seed, 2
TAG = 27-39, seed, 3
TAG = 40-52, seed, 4
TAGS = seed|value, $aaaaa|==1011121301, Royal flush
TAGS = seed|value, $aaaaa|£1111!1>14, Straight flush
TAGS = value, $aaaab, Four of a kind
TAGS = value, $aabbb, Full house
TAGS = seed, $aaaaa, Flush
TAGS = value, £1111!1>14, Straight
TAGS = value, $aaabc, Three of a kind
TAGS = value, $aabbc, Two pairs
TAGS = value, $aabcd, One pair
TAGS = value, $abcde, No pair

```

TEXT

This directive writes a text on a range of cards. The font used is specified using FONT (see page 113) or FONTRANGE (see page 115) command.

Syntax:

TEXT = “range”, “text”, pos x, pos y, width, height, *horizontal alignment*, *vertical alignment*, *angle*, *alpha*, *outline width*, *circle offset*, *circle angle*, *width factor*, *height factor*

Parameters:

“range”: a set of cards

“text”: the text to be printed

pos x: horizontal position (in cm)

pos y: vertical position (in cm)

width: width of the rectangle used to draw the text (in cm); you can specify a negative number for a text mirrored horizontally

height: height of the rectangle used to draw the text (in cm); you can specify a negative number for a text mirrored vertically

horizontal alignment: the text’s horizontal alignment in the rectangle, values accepted are:

- left left aligned
- center centered
- right right aligned

The horizontal alignment is optional, if omitted is equal to **center**.

vertical alignment: the text’s vertical alignment in the rectangle, values accepted are:

- top top aligned
- center centered
- bottom bottom aligned
- wordwrap the text is top aligned and word-wrapped in the rectangle
- wwtop the text is top aligned and word-wrapped in the rectangle
- wwcenter the text is center aligned and word-wrapped in the rectangle
- wwbottom the text is bottom aligned and word-wrapped in the rectangle
- charwrap the text is centered, spaced and word-wrapped (every character) in a pattern

The vertical alignment is optional, if omitted is equal to **center**.

angle: angle of text rotation, if omitted is 0 (no rotation)

alpha: level of transparency of text, from 0 (full transparent) to 100 (full solid). If omitted, the level is set to 100 (full solid). You can also specify an angle for the transparency, with the format **level@angle**; in this case, the level of transparency is the starting level, ending with 0 (full transparent)

outline width: if you specify a number, the font is drawn as outlined, with this number as line's width

circle offset: if you specify a number, this is the offset for a circular text (from 0 to 100), the default is 25

circle angle: if you specify a number, this is the angle of each letter in a circular text, the default is 0

width factor: if you specify a number, the text is horizontally stretched (the default is 100)

height factor: if you specify a number, the text is vertically stretched (the default is 100)

If you want a more flexible command for text, you can use HTMLTEXT (with HTMLFONT, HTMLMARGINS, HTMLIMAGE, and HTMLKEY). With these commands, you can use multiple fonts, sizes, colors, images, justified alignment and more (anything you can write with an HTML editor).

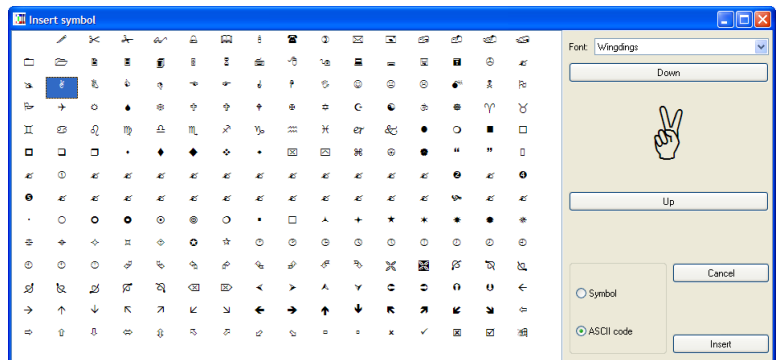

Tip: you can choose a single specific symbol or character from a visual form, clicking on the button “Insert” and choosing the menu voice “Symbol”.

Examples:

```
RECTANGLE = 1, 1, 1, 4, 7, #0000FF
FONT = Arial, 16, T, #FFFFFF
TEXT = 1, "center-top", 1, 1, 4, 2, center, top
```

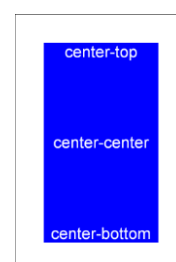

Figure 66

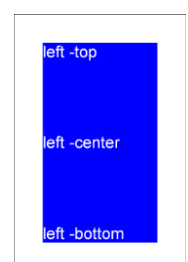

Figure 65

```
TEXT = 1, "center-center", 1, 3, 4, 3, center, center
TEXT = 1, "center-bottom", 1, 6, 4, 2, center, bottom
```

Result: Figure 66

```
RECTANGLE = 1, 1, 1, 4, 7, #0000FF
FONT = Arial, 16, T, #FFFFFF
TEXT = 1, "left-top", 1, 1, 4, 2, left, top
TEXT = 1, "left-center", 1, 3, 4, 3, left, center
TEXT = 1, "left-bottom", 1, 6, 4, 2, left, bottom
```

Result: Figure 65

```
RECTANGLE = 1, 1, 1, 4, 7, #0000FF
FONT = Arial, 16, T, #FFFFFF
TEXT = 1, "right-top", 1, 1, 4, 2, right, top
TEXT = 1, "right-center", 1, 3, 4, 3, right, center
TEXT = 1, "right-bottom", 1, 6, 4, 2, right, bottom
```

Result: Figure 68

```
[test] = "Lorem ipsum dolor sit amet, consectetuer
adipiscing elit. Aenean fermentum ipsum eu sapien."
```

```
RECTANGLE = 1, 1, 1, 4, 7, #0000FF
FONT = Arial, 12, T, #FFFFFF
TEXT = 1, [test], 1, 1, 4, 7, left, wwtop
```

Result: Figure 67

```
[test] = "Lorem ipsum dolor sit amet, consectetuer adipiscing elit. Aenean
fermentum ipsum eu sapien."
```

```
RECTANGLE = 1, 1, 1, 4, 7, #0000FF
FONT = Arial, 12, T, #FFFFFF
TEXT = 1, [test], 1, 1, 4, 7, center, wwcenter
```

Result: Figure 70

```
[test] = "Lorem ipsum dolor sit amet, consectetuer adipiscing elit. Aenean
fermentum ipsum eu sapien."
```

```
RECTANGLE = 1, 1, 1, 4, 7, #0000FF
FONT = Arial, 12, T, #FFFFFF
TEXT = 1, [test], 1, 1, 4, 7, right, wwbottom
```

Result: Figure 69

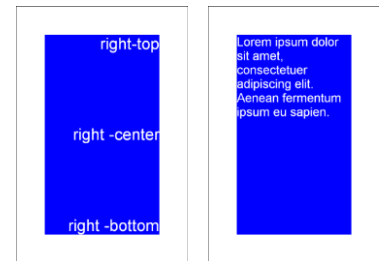

Figure 68

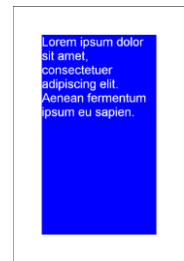

Figure 67

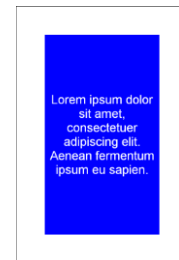

Figure 70

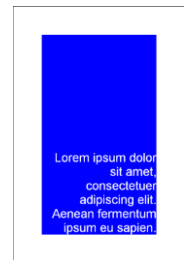

Figure 69

TEXTFONT

This directive writes a text on a range of cards, it uses the parameters both from TEXT (see page 180) and FONT (see page 113) directives.

Syntax:

TEXTFONT = "range", "text", pos x, pos y, width, height, *horizontal alignment*, *vertical alignment*, *angle*, *alpha*, "font name", font size, style, html color font, html color background, outline width, circle offset, circle angle, char space, width factor, height factor

TEXTLIMIT

This directive fills four variables with the coordinates of latest drawn text's boundaries (in cm), from TEXT (see page 180) or HTMLTEXT (see page 127, in this case a L flag gives more precision) commands. Note that you must specify the TEXTLIMIT line after the TEXT/HTMLTEXT. You can use these variables in other commands.

Syntax:

TEXTLIMIT = "range", switch text, switch htmltext

The four variables are:

```
TL    (left)
TR    (right)
```

TT (top)
TB (bottom)

Parameters:

“**range**”: a set of cards

switch text: values accepted are:

ON from now on, all TEXT directives are considered to have automatically a TEXTLIMIT
OFF default behavior, TEXT LIMIT must be explicitly added

switch htmltext: values accepted are:

ON from now on, all HTMLTEXT directives are considered to have automatically a TEXTLIMIT
OFF default behavior, TEXTLIMIT must be explicitly added

Example:

```
FONT = Arial, 16, , #000000
TEXT = 1, "This is a test", 0, 0, 6, 2, center, center
TEXTLIMIT = 1
LINE = 1, TL, 0, TL, 2, #000000, 0.05
LINE = 1, TR, 0, TR, 2, #000000, 0.05
LINE = 1, 0, TT, 6, TT, #000000, 0.05
LINE = 1, 0, TB, 6, TB, #000000, 0.05
```

Result: Figure 71



This is a test

Figure 71

THREADS

When the deck is built, if you specify a number different from one, nanDECK executes *n* copies of itself that render a section of the current deck. The main program waits until all the sections are complete and loads them in the current deck. With a multithreaded CPU, the result is a shorter time for building a deck.

Syntax:

THREADS = number

Parameter:

number: the number of threads that must be used

Example:

```
THREADS = 4
```

Note: this method works if the cards are made independently each other, it cannot be used if in the script there are keywords like COPYCARD or DUPLEX.

TOKEN

This directive prepares a token to be used in the “Virtual table” option (see page 71). A token in the Virtual table can be a simple counter with a text that can be moved or stacked, or a dice that can be rolled to obtain random values.

Syntax:

TOKEN = “formula”, width, height, font color, back color, *number*, *pos x*, *pos y*, *sequence*, *starting frames*, *frames*, *rules*, *chromakey*, *flag*

Parameters:

“formula”: the text visualized in the token, can be an empty string or it can be used an expression. If you use an expression with a “d” for a random value, it can be rolled like a die with a double-click of the mouse on the token itself

width: width of the token (in pixels), you can also specify a % of the screen width

height: height of the token (in pixels), you can also specify a % of the screen height

font color: font color in the same format used for HTML

back color: background color in the same format used for HTML

number: the number of tokens (one, if not specified), if more than one the tokens are stacked together on the table

pos x: horizontal position for the token (in pixels), you can also specify a % of the screen’s width

pos y: vertical position for the token (in pixels), you can also specify a % of the screen’s height

sequence: a sequence of images from which is extracted the image shown on the token (the position of the image extracted is specified in the formula as a number, and it can be a random value)

starting frames: if specified, the token is placed in a frame randomly taken from this list

frames: when a token is moved on the table, it is positioned in the nearest frame from this list

rules: when a token is moved on the table, are enforced the rules specified in this parameter (see page 71 for a list of the rules)

chromakey: the color in the token specified in this parameter is treated as transparent, or the transparent color will be taken from one of the four corners or the center of the token, as specified by one of these keywords:

TOPLEFT
TOPRIGHT
BOTTOMLEFT
BOTTOMRIGHT
CENTER
NULL

flags: you can choose these flags:

F the token is always placed in front of the cards
B the token is always placed behind the cards

Examples:

```
TOKEN = "{1d6}", 50, 50, #FFFFFF, #0000FF
```

```
TOKEN = "$", 100, 50, #FFFFFF, #00FF00, 10
```

TRACK

This directive draws a racetrack section from a point (x1, y1) to another point (x2, y2).

Syntax:

TRACK = “range”, pos x1, pos y1, pos x2, pos y2, track width, html color, *num lanes*, *num spaces*, *flags*, *thickness*, *left factor*, *right factor*, *pattern*

Parameters:

“range”: a set of cards

pos x1, pos y1: coordinates of first point (in cm)

pos x2, pos y2: coordinates of second point (in cm)

track width: width of the track (in cm)

html color: color of the track, in the same format used for HTML, you can also specify a gradient

num lanes: the number of the lanes that compose the track, the minimum is one

num spaces: the number of spaces long the track, the minimum is one

flags: you can choose these flags:

S the track section is closed at the start
E the track section is closed at the end
H even lanes are drawn forward one-half space
L the track is linked, using a line, to the last track drawn on the same card
C the track is linked, using a curve, to the last track drawn on the same card
R do not draw external right link
F do not draw external left link

thickness: thickness of the track's line (in cm), if omitted, the line is 1 pixel wide

left factor: for curved link, this parameter set the width of the curve, for the left side of the track

right factor: for curved link, this parameter set the width of the curve, for the right side of the track

pattern: a pattern for the track's line, this pattern can be composed of:

O dot
D dash
S space

These letters can be repeated, for example "OSDSOS" is a valid pattern.

Example:

```
TRACK = 1, 1, 8, 5, 1, 1, #000000, 3, 4, SE, 0.1
```

Result: Figure 72

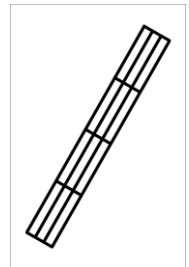

Figure 72

TRACKRECT

This directive draws a racetrack section from a vertex of a rectangle to the opposite vertex.

Syntax:

TRACK = "range", pos x, pos y, width, height, track width, html color, num lanes, num spaces, flags, thickness, left factor, right factor, pattern

Parameters:

"range": a set of cards

pos x: horizontal position (in cm)

pos y: vertical position (in cm)

width: width of the rectangle (in cm)

height: height of the rectangle (in cm)

track width: width of the track (in cm)

html color: color of the track, in the same format used for HTML, you can also specify a gradient

num lanes: the number of the lanes that compose the track, the minimum is one

num spaces: the number of spaces long the track, the minimum is one

flags: you can choose these flags:

S	the track section is closed at the start
E	the track section is closed at the end
H	even lanes are drawn forward one-half space
L	the track is linked, using a line, to the last track drawn on the same card
C	the track is linked, using a curve, to the last track drawn on the same card
R	do not draw external right link
F	do not draw external left link

thickness: thickness of the track's line (in cm), if omitted, the line is 1 pixel wide

left factor: for curved link, this parameter set the width of the curve, for the left side of the track

right factor: for curved link, this parameter set the width of the curve, for the right side of the track

pattern: a pattern for the track's line, this pattern can be composed of:

O	dot
D	dash
S	space

These letters can be repeated, for example "OSDSOS" is a valid pattern.

TRANSFORM

This directive applies a projection transformation (on a quadrilateral) to all the images uploaded with an IMAGE directive or a LAYER structure. If you want to reset this setting, use only the range parameter, without coordinates.

Syntax:

TRANSFORM = "range", *x1*, *y1*, *x2*, *y2*, *x3*, *y3*, *x4*, *y4*

Parameters:

"range": a set of cards

x1: horizontal position (in %) of the top-left vertex

y1: vertical position (in %) of the top-left vertex

x2: horizontal position (in %) of the top-right vertex

y2: vertical position (in %) of the top-right vertex

x3: horizontal position (in %) of the bottom-right vertex

y3: vertical position (in %) of the bottom-right vertex

x4: horizontal position (in %) of the bottom-left vertex

y4: vertical position (in %) of the bottom-left vertex

TRIANGLE

This directive draws a triangle in a set of cards.

Syntax:

TRIANGLE = “range”, pos x1, pos y1, pos x2, pos y2, pos x3, pos y3, html color, *html color*, *thickness*

Parameters:

“range”: a set of cards

pos x1, pos y1: coordinates of 1st point (in cm)

pos x2, pos y2: coordinates of 2nd point (in cm)

pos x3, pos y3: coordinates of 3rd point (in cm)

html color: border color of the triangle, in the same format used for HTML, you can also specify a gradient

html color: inner color of the triangle, in the same format used for HTML, if not specified the inner color is the same of border color. You can also specify “EMPTY” for a hollow triangle or a gradient

thickness: thickness of the border of the triangle (in cm), if omitted, the triangle’s border is 1 pixel wide

Examples:

```
TRIANGLE = 1, 1, 8, 3, 1, 5, 8, #00FF00
```

Result: Figure 73

```
TRIANGLE = 1, 1, 8, 3, 1, 5, 8, #FF00FF, EMPTY, 0.1
```

Result: Figure 74

```
TRIANGLE = 1, 1, 8, 3, 1, 5, 8, #FF0000#0000FF@90
```

Result: Figure 75

UNIT

This directive chooses a unit to be used with all the numeric size in the script. For a correct use, it is better to include it in the first line of the script. The default size unit, if UNIT is not used, is the “cm”.

Syntax:

UNIT = type

Parameters:

type: the type of unit can be chosen between:

CM

MM

INCH

Example:

```
UNIT = inch
```

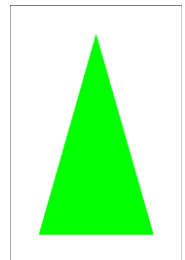

Figure 73

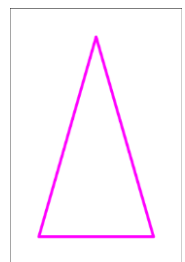

Figure 74

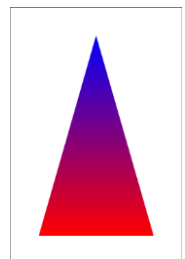

Figure 75

Tip: instead of using absolute values, you can always specify a size (in every directive) as a fraction of the whole card, using number followed by the percentage “%”.

VECTOR

This directive draws an SVG file in a set of cards.

Syntax:

VECTOR = “range”, “image file”, pos x, pos y, width, height, *angle*, *alpha*, *flags*, “from”, “to”

Parameters:

“**range**”: a set of cards

“**image file**”: an existent .svg image file (eventually with a path)

pos x: horizontal position (in cm)

pos y: vertical position (in cm)

width: width of the image (in cm)

height: height of the image (in cm)

angle: angle of image rotation, can be 0 for no rotation

alpha: level of transparency of image, from 0 (full transparent) to 100 (full solid). If omitted, the level is set to 100 (full solid)

flags: you can choose these flags:

I use the internal engine (default)

E use Inkscape for image’s rendering (you must specify the path in the Config window)

“**from**”: string to replace in the .svg file with the next parameter

“**to**”: string with which the one indicated in the previous parameter is replaced

Example:

```
VECTOR=1-10, test.svg, 0, 0, 4, 4
```

Note: with the internal engine, the SVG file specifications are not fully implemented, some issues exist (for example, in gradient fill).

VISUAL

This directive is used to open a VISUAL...ENDVISUAL structure (see “Visual editor”, page 74).

Syntax:

VISUAL = *flags*, *horizontal steps*, *vertical steps*

Parameters:

flags: you can choose these flags:

H show the horizontal ruler

V show the vertical ruler

G show the grid

P snap to the grid when you move an object

S snap to the grid when you resize an object

X set the snap to the grid automatically for all objects

Y set the size to the grid automatically for all objects

horizontal steps: number of horizontal steps for the grid

vertical steps: number of vertical steps for the grid

VORONOI

This directive draws a Voronoi diagram in a card. To specify the points, you use frames with a color as 5th parameter (you can also use a gradient with multiple colors or add the “strength” of the point after a % symbol); the color can also be specified with a TAGFRAME function.

Syntax:

VORONOI = “range”, pos x, pos y, width, height, frames, *flags*, *separation*

Parameters:

“range”: a set of cards

pos x: horizontal position (in cm)

pos y: vertical position (in cm)

width: width of the image (in cm)

height: height of the image (in cm)

frames: the frames used to plot points; you can use * in the name

flags: you can choose these flags:

E the distances are measured using an “Euclidean” formula (square root and powers)

M the distances are measured using a “Manhattan” formula (absolute differences)

R the colors are drawn with a gradient calculated using RGB color space

H the colors are drawn with a gradient calculated using HSB color space

separation: width of the separation (in cm) between zones

Example:

```
<vor01> = 2, 2, 0, 0, #FF0000
<vor02> = 4, 2, 0, 0, #00FF00
<vor03> = 2, 7, 0, 0, #0000FF
<vor04> = 4, 7, 0, 0, #00FFFF
<vor05> = 3, 4.5, 0, 0, #FFFF00
VORONOI = 1, 1, 1, 4, 7, voro*
```

ZOOM

This directive changes the size of cards (all elements, FONT included). Useful to change the result without having to modify all the data. If omitted, is 100 (and there is no change in size). You can specify a 2nd parameter for vertical zoom if it is different from horizontal one.

Syntax:

ZOOM = width, *height*

Examples:

```
;half size
ZOOM = 50
```

```
;double size  
ZOOM = 200
```

Code examples

Wargame counters

```

cardsize=2,2
dpi=600
linkmulti=number
link=data.txt

[back_ger]=#C0C0C0
[front_ger]=#000000
[out_ger]=#808080

[back_fre]=#8ADDF4
[front_fre]=#000000
[out_fre]=#808080

macro=outline,(range1),(text1),(frame),(font1),(size1),(col1),(col2),(col3)
font=(font1),(size1),,(col3),(col2),0.01,0.01
text=(range1),(text1),(frame)
font=(font1),(size1),T,(col1),(col2)
text=(range1),(text1),(frame)
end

[all]=1-{(number)}
<cnt_all>=0,0,2,2
<val_lft>=0.25,1.25,0.5,0.75
<val_cnt>=0.75,1.25,0.5,0.75
<val_rgt>=1.25,1.25,0.5,0.75
<val_id>=0.25,0,1.5,0.25
<img_cnt>=0.45,0.3,1.1,0.9
<img_cnt2>=0.6,0.5,0.8,0.5
rectangle=[all],0,0,2,2,[back_[nation]]

outline=[all],[combat],<val_lft>,Arial,16,[front_[nation]],[back_[nation]],[out_[nation]]
outline=[all],[movement],<val_rgt>,Arial,16,[front_[nation]],[back_[nation]],[out_[nation]]
if=[command]<>0
outline=[all],[command],<val_cnt>,Arial,16,[front_[nation]],[back_[nation]],[out_[nation]]
endif
outline=[all],[id],<val_id>,Arial,7,[front_[nation]],[back_[nation]],[out_[nation]]
if=[type]=inf
line=[all],<img_cnt,PTL>,<img_cnt,PBR>,[front_[nation]],0.04
line=[all],<img_cnt,PBL>,<img_cnt,PTR>,[front_[nation]],0.04
line=[all],<img_cnt,PTL>,<img_cnt,PBR>,[out_[nation]],0.02
line=[all],<img_cnt,PBL>,<img_cnt,PTR>,[out_[nation]],0.02
endif
if=[type]=cav
line=[all],<img_cnt,PBL>,<img_cnt,PTR>,[front_[nation]],0.04
line=[all],<img_cnt,PBL>,<img_cnt,PTR>,[out_[nation]],0.02
endif
if=[type]=arm
ellipse=[all],<img_cnt2>,[front_[nation]],EMPTY,0.04
ellipse=[all],<img_cnt2>,[out_[nation]],EMPTY,0.02
endif
if=[type]=hq
outline=[all],HQ,<img_cnt>,Arial,16,[front_[nation]],[back_[nation]],[out_[nation]]
endif
rectangle=[all],<img_cnt>,[front_[nation]],"empty",0.05
rectangle=[all],<img_cnt>,[out_[nation]],"empty",0.02

```

Data file (data.txt):

```

nation,type,combat,movement,command,id,number
fre,inf,3,3,0,XXX,2
fre,cav,2,5,0,XX,2
fre,arm,4,4,0,XXX,2
fre,arm,5,4,0,XXX,2
fre,hq,1,4,3,"De Gaulle",1
ger,inf,3,3,0,XXX,2
ger,inf,3,3,0,XXXX,2
ger,arm,6,5,0,XXX,2
ger,arm,5,4,0,XXX,2
ger,hq,1,5,3,Rommel,1

```

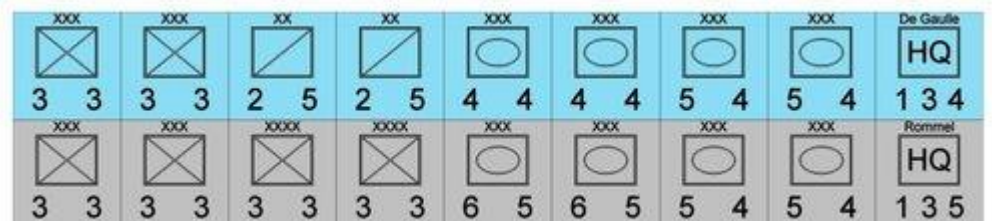

Dice results

```
cardsize=18,3
border=rectangle
zoom=50
[all]=1-36
```

```
<d4>=0,0,3,3
<d6>=3,0,3,3
<d8>=6,0,3,3
<d10>=9,0,3,3
<d12>=12,0,3,3
<d20>=15,0,3,3
```

```
[col]=#000000
```

```
font=Arial,32,T,[col]
```

```
polygon=[all],<d4>,3,0,[col],EMPTY,0.1
text=[all],"{1d4}",<d4>
```

```
polygon=[all],<d6>,4,45,[col],EMPTY,0.1
text=[all],"{1d6}",<d6>
```

```
polygon=[all],<d8>,4,0,[col],EMPTY,0.1
text=[all],"{1d8}",<d8>
```

```
line=[all],9,1,10.5,0,[col],0.1
line=[all],10.5,0,12,1,[col],0.1
line=[all],12,1,10.5,3,[col],0.1
line=[all],10.5,3,9,1,[col],0.1
text=[all],"{1d10}",<d10>
```

```
polygon=[all],<d12>,5,0,[col],EMPTY,0.1
text=[all],"{1d12}",<d12>
```

```
polygon=[all],<d20>,3,90,[col],EMPTY,0.1
text=[all],"{1d20}",<d20>
```

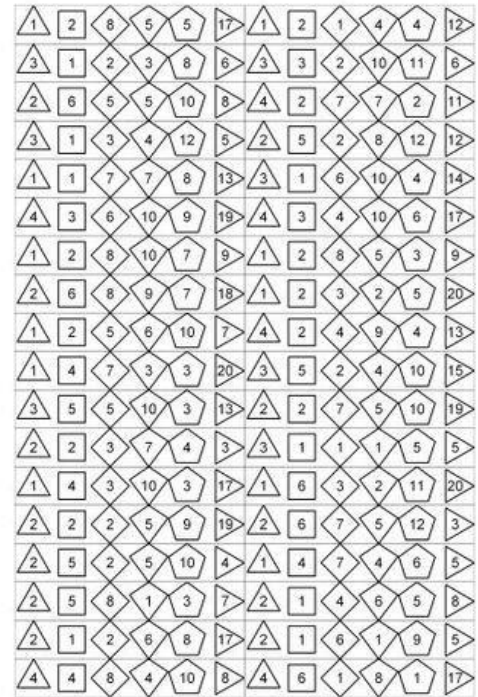

Score track

```
unit=inch
canvassize=15,15

[side_a]=framebox(0,0,14,1,1,1,C)
[side_b]=framebox(14,0,1,14,1,1,C)
[side_c]=framebox(1,14,14,1,1,1,C)
[side_d]=framebox(0,1,1,14,1,1,C)

rectangle=0,<side*>,#000000,empty

font=arial,16,T,#000000
text=0,"{-1}",<side_a*>
text=0,"{13+°}",<side_b*>,center,center,90
text=0,"{26+16-°}",<side_c*>,center,center,180
text=0,"{40+16-°}",<side_d*>,center,center,270

save=0,"board.png"0,0,15,15
```

0	1	2	3	4	5	6	7	8	9	10	11	12	13	14
15														15
16														16
17														17
18														18
19														19
20														20
21														21
22														22
23														23
24														24
25														25
26														26
27														27
28	29	30	31	32	33	34	35	36	37	38	39	40	41	28

Boggle dice

```
N[a]=01|02|03|04|05|06|07|08|09|10|11|12|13|14|15|16
[range]=1-{(a)}
[d01]=LRYTTE
[d02]=VTHRWE
[d03]=EGHWNE
[d04]=SEOTIS
[d05]=ANAEEG
[d06]=IDSYTT
[d07]=OATTOW
[d08]=MTOICU
[d09]=AFPKFS
[d10]=XLDERI
[d11]=HCPOAS
[d12]=ENSIEU
[d13]=YLDEVVR
[d14]=ZNRNHL
[d15]=NMIQHU
[d16]=OBBAOJ
CARDSIZE = 4.5, 4.5
FONT = Arial, 96, , #000000
TEXT = [range], [[d[a]]:d6,1], 0, 0, 100%, 100%
RECTANGLE = [range], 0, 0, 100%, 100%, #0000FF, EMPTY, 10%
```

N	S	R	O
V	O	V	L
E	O	S	E
I	T	H	E

Catan map

```
canvassize=35,35
[sea]=framehex(0,0,35,35,3,C)
[map]=framedisk(sea43,sea41)
'sea
polygon=0,<sea*>,6,90,#000000,#0000FF,0.1
'field
polygon=0,<4~!map*>,6,90,#000000,#CEC90B,0.1
'forest
polygon=0,<4~!map*>,6,90,#000000,#008000,0.1
'pasture
polygon=0,<4~!map*>,6,90,#000000,#80FF00,0.1
'mountain
polygon=0,<3~!map*>,6,90,#000000,#C0C0C0,0.1
'hill
polygon=0,<3~!map*>,6,90,#000000,#800000,0.1
'desert
polygon=0,<~!map*>,6,90,#000000,#FFFF80,0.1

save=0,"catan.jpg",0,0,35,35
```

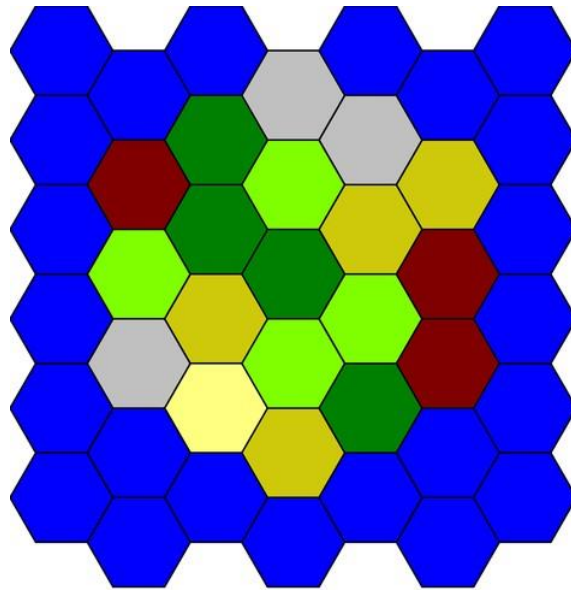

Clock

```
cardsize = 10,10
[clock] = frameclock(1, 1, 8, 8, 2, 2, 12)
ellipse = 1, <clock*>, #CCCCCC
font = Arial, 32, T, #000000
text = 1, "{°}", <clock*>, center, center, °*360/12

layer = 50
;hours
[hour] = frameclock(2, 2, 6, 6, 1, 1, 12)
line = 1, 5, 5, <hour4, PCC>, #FF0000, 0.6

;minutes
line = 1, 5, 5, <clock2, PCC>, #0000FF, 0.4
endlayer
```

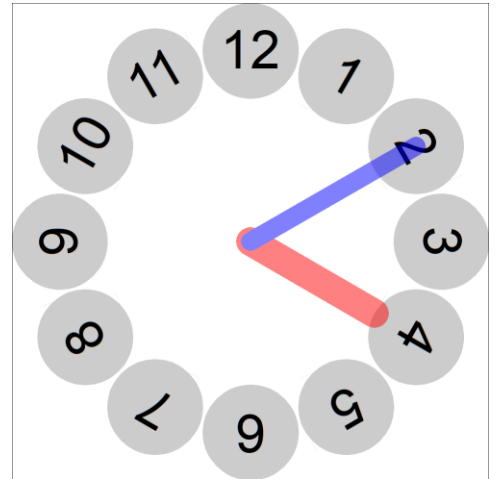

Hex board

```
page=21.59,27.94,portrait,hv
cardsize=16,24
border=None
[base]=framehex(0,0,16,24,0.85,C)
[hex01]=frameline(base0101,base0111)
[hex02]=frameline(base0201,base0211)
[hex03]=frameline(base0302,base0312)
[hex04]=frameline(base0402,base0412)
[hex05]=frameline(base0503,base0513)
[hex06]=frameline(base0603,base0613)
[hex07]=frameline(base0704,base0714)
[hex08]=frameline(base0804,base0814)
[hex09]=frameline(base0905,base0915)
[hex10]=frameline(base1005,base1015)
[hex11]=frameline(base1106,base1116)
polygon=1,<hex*>,6,90,#000000,EMPTY,0.1
```

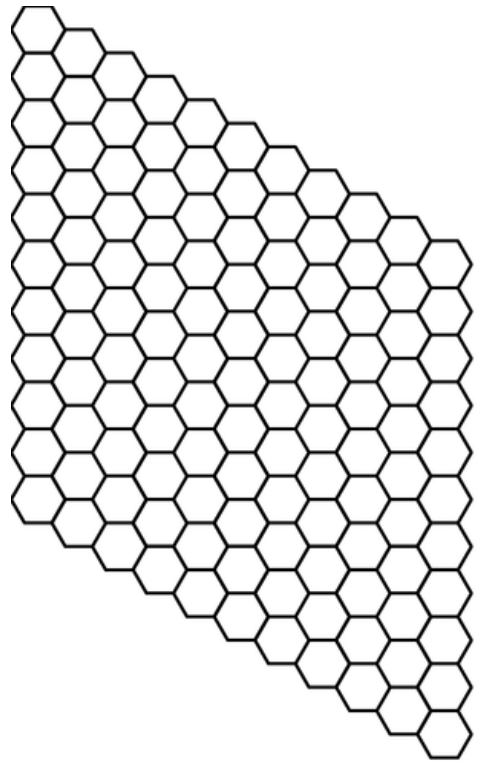

Triangle map

```
canvassize=21,27
[h]=framehex(0,0,21,27,1,C)
star=0,<h*>,6,90,1,#000000,EMPTY,0.05
hexgrid=0,0,0,21,27,1,,#000000,EMPTY,0.05
save=0,"triangle.png",0,0,21,27
```

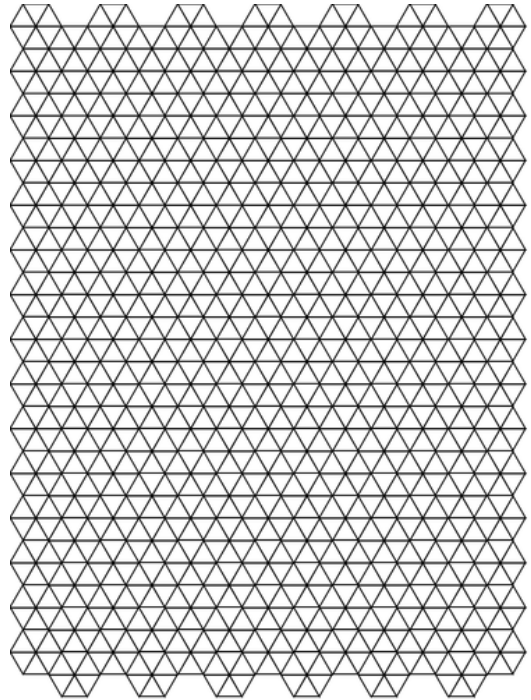

Chess board

With font "Chess Cases". Link: <http://www.enpassant.dk/chess/fonteng.htm#CASES>

```

canvassize=18,18
[ch]=framebox(1,1,16,16,2,2,E)
{[ch_white]=framelist(cha1, chc1, che1, chg1, chb2, chd2, chf2, chh2, cha3, chc3, che3, chg3, chb4, chd4, chf4, chh4,
cha5, chc5, che5, chg5, chb6, chd6, chf6, chh6, cha7, chc7, che7, chg7, chb8, chd8, chf8, chh8) }
{[ch_black]=framelist(chb1, chd1, chf1, chh1, cha2, chc2, che2, chg2, chb3, chd3, chf3, chh3, cha4, chc4, che4, chg4,
chb5, chd5, chf5, chh5, cha6, chc6, che6, chg6, chb7, chd7, chf7, chh7, cha8, chc8, che8, chg8) }
rectangle=0,<ch_white>,#EEEEEE
rectangle=0,<ch_black>,#BBBBBB
[tt]=framebox(1,0,16,1,2,1,N)
[tb]=framebox(1,17,16,1,2,1,N)
[t1]=framelist(tt1,tb1)
[t2]=framelist(tt2,tb2)
[t3]=framelist(tt3,tb3)
[t4]=framelist(tt4,tb4)
[t5]=framelist(tt5,tb5)
[t6]=framelist(tt6,tb6)
[t7]=framelist(tt7,tb7)
[t8]=framelist(tt8,tb8)
[s1]=framebox(0,1,1,16,1,2,N)
[sr]=framebox(17,1,1,16,1,2,N)
[s1]=framelist(s11,sr1)
[s2]=framelist(s12,sr2)
[s3]=framelist(s13,sr3)
[s4]=framelist(s14,sr4)
[s5]=framelist(s15,sr5)
[s6]=framelist(s16,sr6)
[s7]=framelist(s17,sr7)
[s8]=framelist(s18,sr8)
font=arial,16,,#000000
text=0,a,<t1>
text=0,b,<t2>
text=0,c,<t3>
text=0,d,<t4>
text=0,e,<t5>
text=0,f,<t6>
text=0,g,<t7>
text=0,h,<t8>
text=0,8,<s1>
text=0,7,<s2>
text=0,6,<s3>
text=0,5,<s4>
text=0,4,<s5>
text=0,3,<s6>
text=0,2,<s7>
text=0,1,<s8>
font="chess cases",48,T,#000000
[wpa]=p
[wkn]=n
[wbi]=b
[wro]=r
[wqu]=q
[wki]=k
[bpa]=o
[bkn]=m
[bbi]=v
[bro]=t
[bqu]=w
[bki]=l
text=0,[wpa],<ch?7>
text=0,[wro],<cha8>
text=0,[wkn],<chb8>
text=0,[wbi],<chc8>
text=0,[wqu],<chd8>
text=0,[wki],<che8>
text=0,[wbi],<chf8>
text=0,[wkn],<chg8>
text=0,[wro],<chh8>
text=0,[bpa],<ch?2>
text=0,[bro],<cha1>
text=0,[bkn],<chb1>
text=0,[bbi],<chc1>
text=0,[bqu],<chd1>
text=0,[bki],<che1>
text=0,[bbi],<chf1>
text=0,[bkn],<chg1>
text=0,[bro],<chh1>
save=0,chessboard2.png,0,0,18,18

```

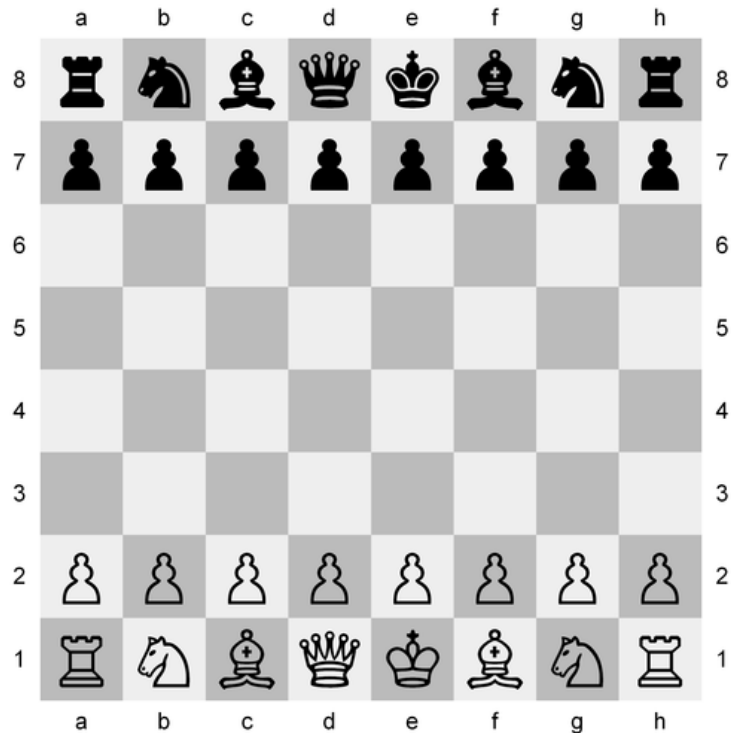

Trivia cards

```
linkmulti=num
link="q&a.txt"
[all]="1-{(id)}"
[card_id]=join("Card #",[id])
[background]=#D0D0D0
[ink]=#000000
[col_q]=#FFFF80
[col_a]=#80FF80
rectangle=[all],0,0,100%,100%,[background]
font=arial,16,,[ink],[background]
text=[all],[card_id],0,0,100%,20%,center,center
roundrect=[all],5%,20%,90%,35%,[col_q],0.1
font=arial,12,,[ink],[col_q]
text=[all],[question],10%,22%,80%,31%,left,wordwrap
roundrect=[all],5%,60%,90%,35%,[col_a],0.1
font=arial,12,,[ink],[col_a]
text=[all],[answer],10%,62%,80%,31%,left,wordwrap
```

Data file (q&a.txt):

```
id,num,question,answer
1,1,"This is question #1","This is answer #1"
2,1,"This is question #2","This is answer #2"
3,1,"This is question #3","This is answer #3"
4,1,"This is question #4","This is answer #4"
5,1,"This is question #5","This is answer #5"
6,1,"This is question #6","This is answer #6"
7,1,"This is question #7","This is answer #7"
8,1,"This is question #8","This is answer #8"
9,1,"This is question #9","This is answer #9"
10,1,"This is question #10","This is answer #10"
```

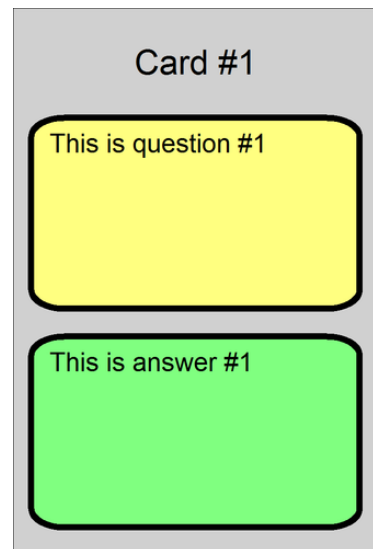

Hex racetrack

```
canvassize=42,44  
[hexa]=framehex(0,0,42,44,1,C)  
[hexb]=framedisk(hexa1412,hexa0112)  
[hexc]=framedisk(hexa1412,hexa0912)  
[hexd]=framesub(hexb*,hexc*)  
polygon=0,<hexd*>,6,90,#000000,EMPTY,0.1  
save=0,"track.png",0,0,42,44
```

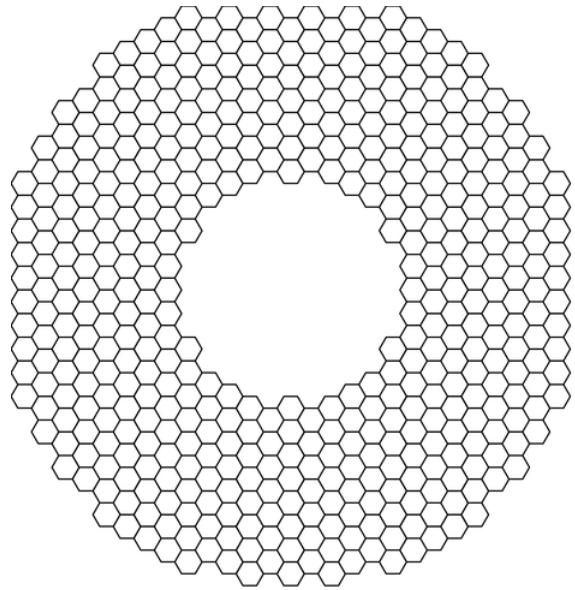

Tuckbox

```

[img1]=none
[img2]=none
INPUTTEXT="wid","Width (cm)","6"
INPUTTEXT="hei","Height (cm)","9"
INPUTTEXT="dep","Depth (cm)","3"
INPUTCHOICE="extra","Add extra lines","Yes","Yes|No"
INPUTTEXT="img1","Box image (front)","",G
INPUTTEXT="img2","Box image (rear)","",G

[fla]=[dep]/2
[ide]=[fla]/2
[coll]=#000000
[col2]=EMPTY
[thi]=0.1

'Uncomment the following line for A4 paper
PAGE=21,29.7, PORTRAIT, HV

'Uncomment the following line for Letter paper
'PAGE=21.59,27.94, PORTRAIT, HV

BORDER=NONE
CARDSIZE=[fla]+[dep]+[hei]+[dep]+[fla],[dep]+[wid]+[dep]+[wid]+[fla]

IF=[img1]=none
ELSE
    IMAGE=1,[img1],[fla]+[dep],[dep],[hei],[wid],90,P
ENDIF

IF=[img2]=none
ELSE
    IMAGE=1,[img2],[fla]+[dep],[dep]+[wid]+[dep],[hei],[wid],90,P
ENDIF

RECTANGLE=1,[fla]+[dep],0,[hei],[dep],[coll],[col2],[thi]
RECTANGLE=1,[fla],[dep],[dep],[wid],[coll],[col2],[thi]
RECTANGLE=1,[fla]+[dep],[dep],[hei],[wid],[coll],[col2],[thi]
RECTANGLE=1,[fla]+[dep]+[hei],[dep],[dep],[wid],[coll],[col2],[thi]
RECTANGLE=1,[fla]+[dep],[dep]+[wid],[hei],[dep],[coll],[col2],[thi]
RECTANGLE=1,[fla]+[dep],[dep]+[wid]+[dep],[hei],[wid],[coll],[col2],[thi]

LINE=1,[fla]+[dep],0,[fla]+[dep]-[fla],[ide],[coll],[thi]
LINE=1,[fla]+[dep]-[fla],[ide],[fla]+[dep]-[fla],[dep]-[ide],[coll],[thi]
LINE=1,[fla]+[dep]-[fla],[dep]-[ide],[fla]+[dep],[dep],[coll],[thi]

LINE=1,[fla]+[dep]+[hei],0,[fla]+[dep]+[hei]+[fla],[ide],[coll],[thi]
LINE=1,[fla]+[dep]+[hei]+[fla],[ide],[fla]+[dep]+[hei]+[fla],[dep]-[ide],[coll],[thi]
LINE=1,[fla]+[dep]+[hei]+[fla],[dep]-[ide],[fla]+[dep]+[hei],[dep],[coll],[thi]

LINE=1,[fla],[dep],[fla]-[fla],[dep]+[ide],[coll],[thi]
LINE=1,[fla]-[fla],[dep]+[ide],[fla]-[fla],[dep]+[wid]-[ide],[coll],[thi]
LINE=1,[fla]-[fla],[dep]+[wid]-[ide],[fla],[dep]+[wid],[coll],[thi]

LINE=1,[fla]+[dep]+[hei]+[dep],[dep],[fla]+[dep]+[hei]+[dep]+[fla],[dep]+[ide],[coll],[thi]
LINE=1,[fla]+[dep]+[hei]+[dep]+[fla],[dep]+[ide],[fla]+[dep]+[hei]+[dep]+[fla],[dep]+[wid]-[ide],[coll],[thi]
LINE=1,[fla]+[dep]+[hei]+[dep]+[fla],[dep]+[wid]-[ide],[fla]+[dep]+[hei]+[dep],[dep]+[wid],[coll],[thi]

LINE=1,[fla]+[dep],[dep]+[wid],[fla]+[dep]-[fla],[dep]+[wid]+[ide],[coll],[thi]
LINE=1,[fla]+[dep]-[fla],[dep]+[wid]+[ide],[fla]+[dep]-[fla],[dep]+[wid]+[dep]-[ide],[coll],[thi]
LINE=1,[fla]+[dep]-[fla],[dep]+[wid]+[dep]-[ide],[fla]+[dep],[dep]+[wid]+[dep],[coll],[thi]

LINE=1,[fla]+[dep]+[hei],[dep]+[wid],[fla]+[dep]+[hei]+[fla],[dep]+[wid]+[ide],[coll],[thi]
LINE=1,[fla]+[dep]+[hei]+[fla],[dep]+[wid]+[ide],[fla]+[dep]+[hei]+[fla],[dep]+[wid]+[dep]-[ide],[coll],[thi]
LINE=1,[fla]+[dep]+[hei]+[fla],[dep]+[wid]+[dep]-[ide],[fla]+[dep]+[hei],[dep]+[wid]+[dep],[coll],[thi]

LINE=1,[fla]+[dep],[dep]+[wid]+[dep]+[wid],[fla]+[dep]+[ide],[dep]+[wid]+[dep]+[wid]+[fla],[coll],[thi]
LINE=1,[fla]+[dep]+[ide],[dep]+[wid]+[dep]+[wid]+[fla],[fla]+[dep]+[hei]-[ide],[dep]+[wid]+[dep]+[wid]+[fla],[coll],[thi]
LINE=1,[fla]+[dep]+[hei]-[ide],[dep]+[wid]+[dep]+[wid]+[fla],[fla]+[dep]+[hei],[dep]+[wid]+[dep]+[wid],[coll],[thi]

IF=[extra]=Yes
    LINE=1,[fla]+[dep]+[hei]-[fla],[dep],[fla]+[dep]+[hei]-[fla],[dep]+[wid],[coll],[thi],DSS
    {
        BEZIER=1,
        [fla]+[dep]+[hei],[dep]+[wid]+[dep]+[wid]/2-[ide],
        [fla]+[dep]+[hei]-[ide],[dep]+[wid]+[dep]+[wid]/2-[ide],
        [fla]+[dep]+[hei]-[ide],[dep]+[wid]+[dep]+[wid]/2+[ide],
        [fla]+[dep]+[hei],[dep]+[wid]+[dep]+[wid]/2+[ide],
        [coll],[thi]}
    }
ENDIF

```

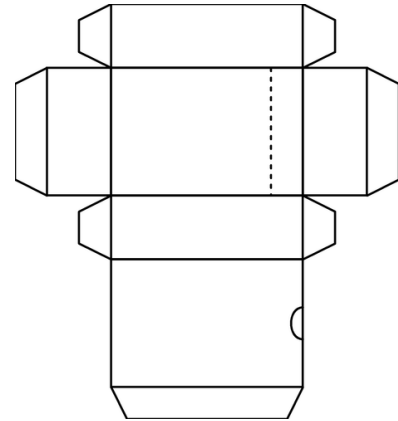

Number wheel

```
[size]=3.5
[numbers]=45
unit=inch
cardsize=[size],[size]
[num]=frameclock(0.1,0.1,[size]-0.2,[size]-0.2,0.3,0.3,[numbers])
[green]=framelist(num1..num15)
[yellow]=framelist(num16..num30)
[red]=framelist(num31..num45)
font=arial,12,T,#000000
ellipse=1,<green>,#00FF00
ellipse=1,<yellow>,#FFFF00
ellipse=1,<red>,#FF0000
text=1,{'-1',<num*>,center,center,°*360/[numbers]-90
ellipse=1,0,0,100%,100%,#000000,empty,0.01
ellipse=1,48%,48%,4%,4%,#000000,empty,0.01
save=1,"wheel_col.png",0,0,100%,100%
```

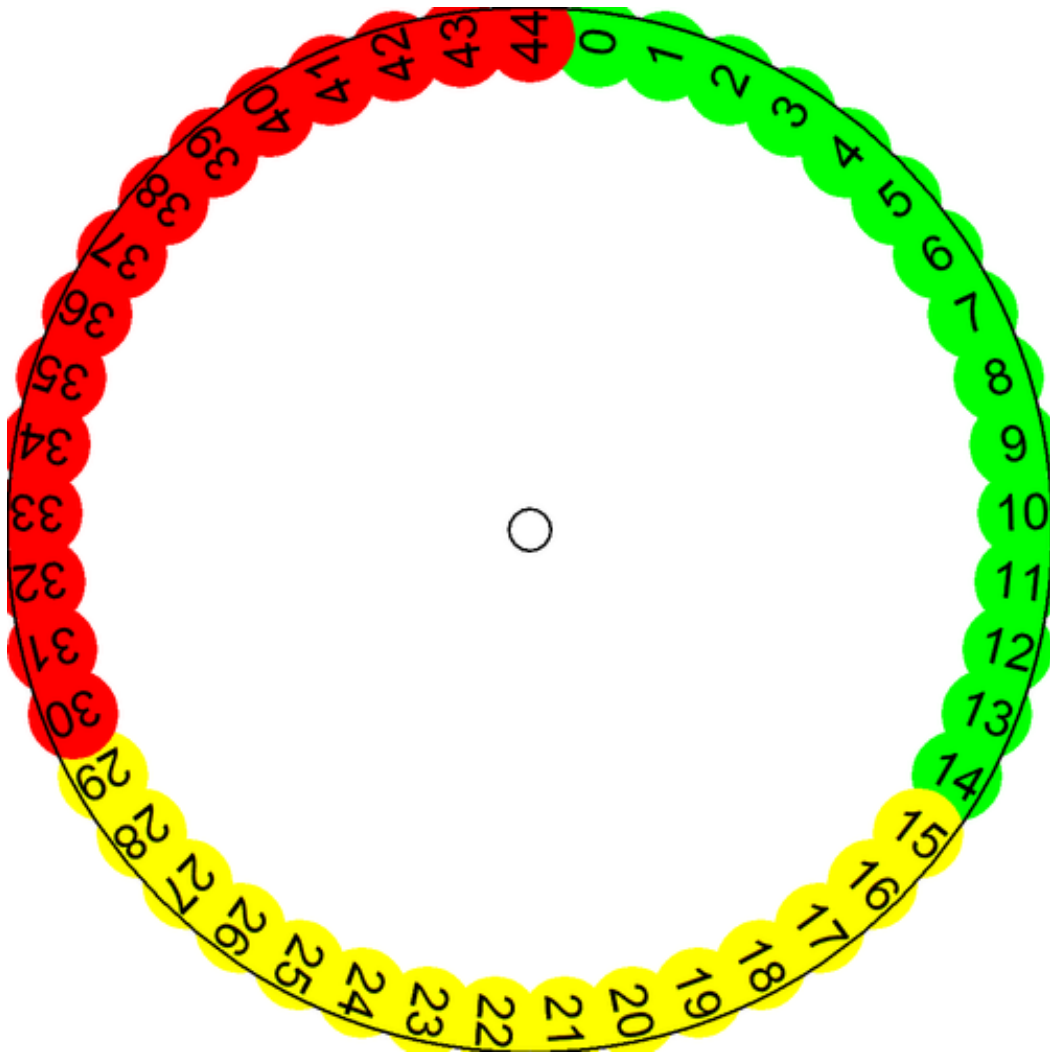

Tripples tiles

```
cardsize=2,2
```

```
'draw and save an image (an arrow)
line=0,1 ,0.2,1 ,1 ,#000000,0.15
line=0,1 ,0.2,1.2,0.4,#0000FF,0.15
line=0,1.2,0.4,0.8,0.4,#0000FF,0.15
line=0,0.8,0.4,1 ,0.2,#0000FF,0.15
save=0,"arrow.bmp",0,0,2,2
```

```
'create all the permutations (256) of two elements (0 and 1) taken eight times
```

```
pr[perm]8=0|1
'takes only the tiles with three '1'
[tiles]=filter(+[perm],3)
```

```
[all]=1-{(tiles)}
'draws a dot
ellipse=[all],0.95,0.05,0.1,0.1,#000000
'draws the eight arrows
if=[tiles:8,1]=1
    image=[all],"arrow.bmp",0,0,2,2,0,T
endif
if=[tiles:7,1]=1
    image=[all],"arrow.bmp",-0.5,-0.5,3,3,45,T
endif
if=[tiles:6,1]=1
    image=[all],"arrow.bmp",0,0,2,2,90,T
endif
if=[tiles:5,1]=1
    image=[all],"arrow.bmp",-0.5,-0.5,3,3,135,T
endif
if=[tiles:4,1]=1
    image=[all],"arrow.bmp",0,0,2,2,180,T
endif
if=[tiles:3,1]=1
    image=[all],"arrow.bmp",-0.5,-0.5,3,3,225,T
endif
if=[tiles:2,1]=1
    image=[all],"arrow.bmp",0,0,2,2,270,T
endif
if=[tiles:1,1]=1
    image=[all],"arrow.bmp",-0.5,-0.5,3,3,315,T
endif
```

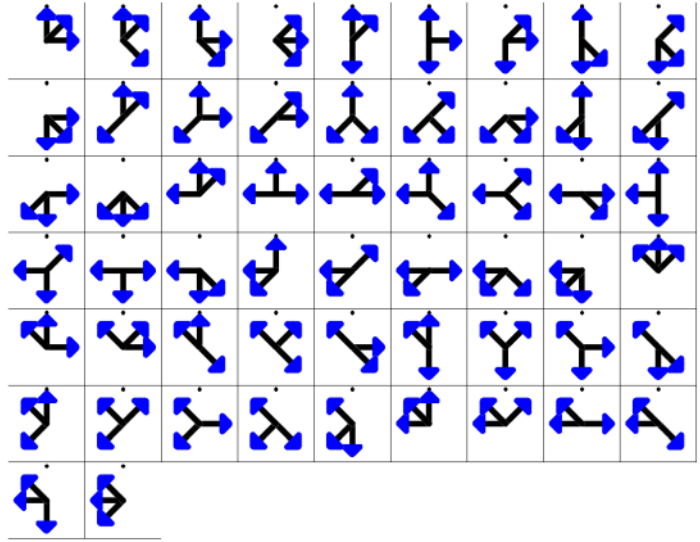

Path tiles

```
oversample=2
macro=tile, (range), (key), (char), (color), (width)
  beziers=(range)
  if=[(key):1,1]=(char)
    beziers=(range),1,0,1,1,(color),(width)
  endif
  if=[(key):2,1]=(char)
    beziers=(range),2,0,2,1,(color),(width)
  endif
  if=[(key):3,1]=(char)
    beziers=(range),3,1,2,1,(color),(width)
  endif
  if=[(key):4,1]=(char)
    beziers=(range),3,2,2,2,(color),(width)
  endif
  if=[(key):5,1]=(char)
    beziers=(range),2,3,2,2,(color),(width)
  endif
  if=[(key):6,1]=(char)
    beziers=(range),1,3,1,2,(color),(width)
  endif
  if=[(key):7,1]=(char)
    beziers=(range),0,2,1,2,(color),(width)
  endif
  if=[(key):8,1]=(char)
    beziers=(range),0,1,1,1,(color),(width)
  endif
end

cardsize=3,3

pxxs[list]8=a|a|b|b|c|c|d|d

[range]=1-{(list)}

tile=[range],[list],a,#000000,0.2
tile=[range],[list],a,#FFFFFF,0.1
tile=[range],[list],b,#000000,0.2
tile=[range],[list],b,#FFFFFF,0.1
tile=[range],[list],c,#000000,0.2
tile=[range],[list],c,#FFFFFF,0.1
tile=[range],[list],d,#000000,0.2
tile=[range],[list],d,#FFFFFF,0.1

rectangle=[range],0,0,3,3,#000000,EMPTY,0.1
```

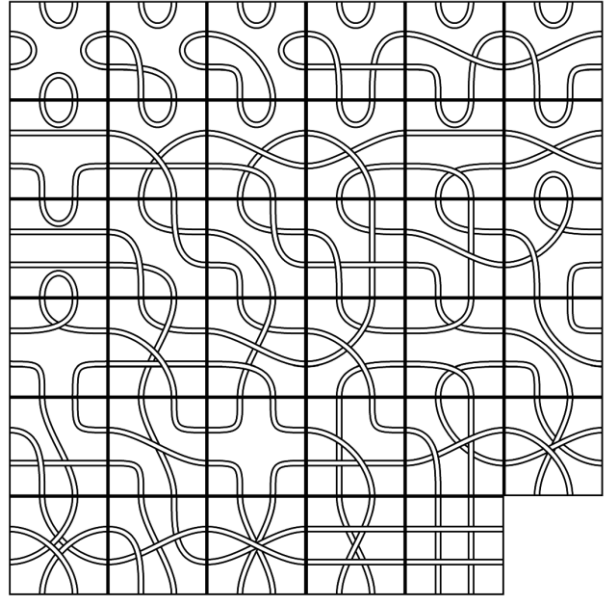

Combinations

```
ellipse=0,0,0,6,6,#FF0000#FFFFFF@360
save=0,a.png,0,0,6,6
ellipse=0,0,0,6,6,#00FF00#FFFFFF@360
save=0,b.png,0,0,6,6
ellipse=0,0,0,6,6,#0000FF#FFFFFF@360
save=0,c.png,0,0,6,6
ellipse=0,0,0,6,6,#FF00FF#FFFFFF@360
save=0,d.png,0,0,6,6
ellipse=0,0,0,6,6,#FFFF00#FFFFFF@360
save=0,e.png,0,0,6,6
ellipse=0,0,0,6,6,#00FFFF#FFFFFF@360
save=0,f.png,0,0,6,6
ellipse=0,0,0,6,6,#000000#FFFFFF@360
save=0,g.png,0,0,6,6

c[comb]3=a|b|c|d|e|f|g
[all]=1-{(comb)}
icon=[all],a,a.png
icon=[all],b,b.png
icon=[all],c,c.png
icon=[all],d,d.png
icon=[all],e,e.png
icon=[all],f,f.png
icon=[all],g,g.png
icons=[all],[comb],1.5,1.5,3,6,3,3,0,P
```

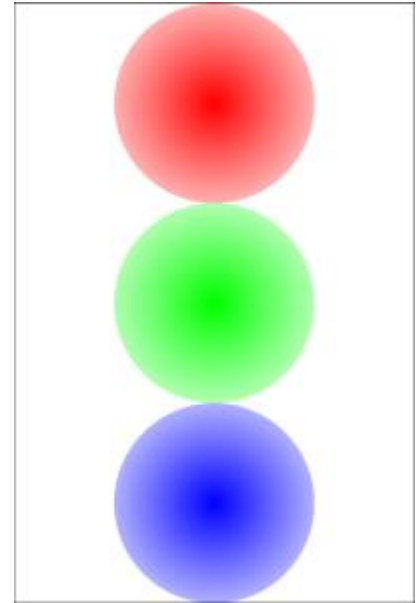

Standard 52-deck of cards

```

sequence=number
A
2
3
4
5
6
7
8
9
10
endsequence

sequence=face
J
Q
K
endsequence

sequence=
suit      |\169\
suit_fnt|Symbol
suit_col|#FF0000

suit      |\168\
suit_fnt|Symbol
suit_col|#FF0000

suit      |\167\
suit_fnt|Symbol
suit_col|#000000

suit      |\170\
suit_fnt|Symbol
suit_col|#000000
endsequence

<corner1_a>=0,0,15%,20%
<corner1_b>=0,0,15%,10%
<corner1_c>=0,10%,15%,10%
<corner2_a>=85%,0,15%,10%
<corner2_b>=85%,10%,15%,10%
<corner3_a>=0,90%,15%,10%
<corner3_b>=0,80%,15%,10%
<corner4_a>=85%,90%,15%,10%
<corner4_b>=85%,80%,15%,10%
<core>=15%,20%,70%,60%

cards={(suit)*((number)+(face))+1}
for=a,1,{(suit)}
  for=b,1,{(number)}
    font=Arial,24,T,{suit_col?a}
    text={b+((a)-1)*((number)+(face))},{number?b},<corner1_a>
    text={b+((a)-1)*((number)+(face))},{number?b},<corner2_a>
    text={b+((a)-1)*((number)+(face))},{number?b},<corner3_a>,center,center,180
    text={b+((a)-1)*((number)+(face))},{number?b},<corner4_a>,center,center,180
    font={suit_fnt?a},32,T,{suit_col?a}
    text={b+((a)-1)*((number)+(face))},{suit?a},<corner1_b>
    text={b+((a)-1)*((number)+(face))},{suit?a},<corner2_b>
    text={b+((a)-1)*((number)+(face))},{suit?a},<corner3_b>,center,center,180
    text={b+((a)-1)*((number)+(face))},{suit?a},<corner4_b>,center,center,180
    text={b+((a)-1)*((number)+(face))},{(suit?a)Xb},<core>,center,charwrap
  next
next
for=a,1,{(suit)}
  for=b,1,{(face)}
    font=Arial,24,T,{suit_col?a}
    text={b+((a)-1)*((number)+(face))+ (number)},{face?b},<corner1_a>
    text={b+((a)-1)*((number)+(face))+ (number)},{face?b},<corner2_a>
    text={b+((a)-1)*((number)+(face))+ (number)},{face?b},<corner3_a>,center,center,180
    text={b+((a)-1)*((number)+(face))+ (number)},{face?b},<corner4_a>,center,center,180
    font={suit_fnt?a},32,T,{suit_col?a}
    text={b+((a)-1)*((number)+(face))+ (number)},{suit?a},<corner1_b>
    text={b+((a)-1)*((number)+(face))+ (number)},{suit?a},<corner2_b>
    text={b+((a)-1)*((number)+(face))+ (number)},{suit?a},<corner3_b>,center,center,180
    text={b+((a)-1)*((number)+(face))+ (number)},{suit?a},<corner4_b>,center,center,180
    font=Arial,128,T,{suit_col?a}
    text={b+((a)-1)*((number)+(face))+ (number)},{face?b},<core>
  next
next

rectangle={(suit)*((number)+(face))+1},0,0,100%,100%,#FF0000#0000FF#90
font=arial,48,DNT,#FFFFFF
text={(suit)*((number)+(face))+1},"nanDECK",0,0,100%,100%

```

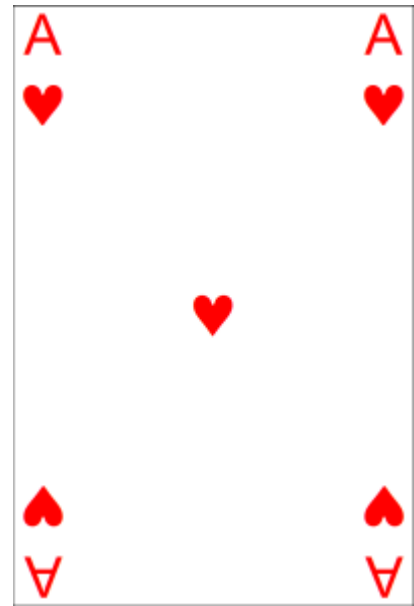

Hexagonal tiles

```

cardsize=5,5
border=none

linkmulti=number
link=data.xlsx
polygon=,0,0,100%,100%,6,30,[color_hex]

[conn]=frameclock(0,0,100%,100%,10%,10%,6)

if=(1@[lines])
line=,<conn1,pcc>,50%,50%,[color_line],15%
endif
if=(2@[lines])
line=,<conn2,pcc>,50%,50%,[color_line],15%
endif
if=(3@[lines])
line=,<conn3,pcc>,50%,50%,[color_line],15%
endif
if=(4@[lines])
line=,<conn4,pcc>,50%,50%,[color_line],15%
endif
if=(5@[lines])
line=,<conn5,pcc>,50%,50%,[color_line],15%
endif
if=(6@[lines])
line=,<conn6,pcc>,50%,50%,[color_line],15%
endif

polygon=,0,0,100%,100%,6,30,#000000,empty,2%

chromakey=#FF0000
layer
polygon=,0,0,100%,100%,6,30,#FF0000
endlayer
save="tile{$}.png",0,6.735%,100%,86.53%,#FF
FFFF

```

	A	B	C	D	E	F
1	Color_hex	Lines	Color_line	Number		
2	#00C500	1	#000000	2		
3	#00C500	12	#000000	2		
4	#00C500	13	#000000	2		
5	#00C500	14	#000000	2		
6	#00C500	123	#000000	2		
7	#00C500	124	#000000	2		
8	#00C500	125	#000000	2		
9	#00C500	135	#000000	2		
10	#00C500	1234	#000000	2		
11	#00C500	1235	#000000	2		
12	#00C500	1245	#000000	2		
13	#00C500	12345	#000000	2		
14	#00C500	123456	#000000	2		
15						
16						

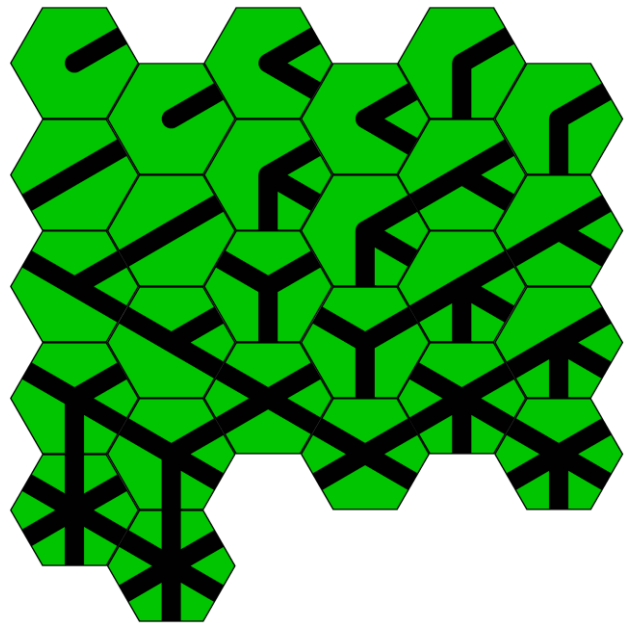

Double-sided printing

page=21,29.7,portrait,hv

link=data.xlsx

```
[range_front]=1-{(front)}  
[range_back]={(front)+1}-{(front)*2}
```

```
font=arial,32,,#FFFFFF,#0000FF  
text=[range_front],[front],0,0,100%,100%
```

```
font=arial,32,,#FFFFFF,#FF0000  
text=[range_back],[back],0,0,100%,100%
```

```
duplex=[range_front],[range_back]  
print=duplex
```

	A	B	C
1	front	back	
2	Front 1	Back 1	
3	Front 2	Back 2	
4	Front 3	Back 3	
5	Front 4	Back 4	
6	Front 5	Back 5	
7	Front 6	Back 6	
8			
9			